

Wireless Home Entertainment System

MX **6000i**



Need help? Call us!

Philips representatives are ready to help you with any questions about your new product. We can guide you through Connections, First-time Setup, or any of the Features. We want you to start enjoying your new product right away!

**CALL US BEFORE YOU CONSIDER
RETURNING THE PRODUCT!**

1-800-531-0039

or

Visit us on the web at www.philips.com



PHILIPS

Return your Product Registration Card today to get the very most from your purchase.

Registering your model with PHILIPS makes you eligible for all of the valuable benefits listed below, so don't miss out. Complete and return your Product Registration Card at once to ensure:

*Proof of Purchase

Returning the enclosed card guarantees that your date of purchase will be on file, so no additional paperwork will be required from you to obtain warranty service.

*Product Safety Notification

By registering your product, you'll receive notification - directly from the manufacturer - in the rare case of a product recall or safety defect.

*Additional Benefits of Product Ownership

Registering your product guarantees that you'll receive all of the privileges to which you're entitled, including special money-saving offers.

PHILIPS

Congratulations on your purchase, and welcome to the "family!"

Dear PHILIPS product owner:

Thank you for your confidence in PHILIPS. You've selected one of the best-built, best-backed products available today. We'll do everything in our power to keep you happy with your purchase for many years to come.

As a member of the PHILIPS "family," you're entitled to protection by one of the most comprehensive warranties and outstanding service networks in the industry. What's more, your purchase guarantees you'll receive all the information and special offers for which you qualify, plus easy access to accessories from our convenient home shopping network.

Most importantly, you can count on our uncompromising commitment to your total satisfaction.

All of this is our way of saying welcome - and thanks for investing in a PHILIPS product.

P.S. To get the most from your PHILIPS purchase, be sure to complete and return your Product Registration Card at once.

Know these
safety symbols



 This "bolt of lightning" indicates uninsulated material within your unit may cause an electrical shock. For the safety of everyone in your household, please do not remove product covering.

 The "exclamation point" calls attention to features for which you should read the enclosed literature closely to prevent operating and maintenance problems.

WARNING: To reduce the risk of fire or electric shock, this apparatus should not be exposed to rain or moisture, and objects filled with liquids, such as vases, should not be placed on this apparatus.

CAUTION: To prevent electric shock, match wide blade of plug to wide slot, fully insert.

ATTENTION: Pour éviter les choc électriques, introduire la lame la plus large de la fiche dans la borne correspondante de la prise et pousser jusqu'au fond.

For Customer Use

Enter below the Serial No. which is located on the rear of the cabinet. Retain this information for future reference.

Model No. _____

Serial No. _____

PHILIPS

Visit our World Wide Web Site at <http://www.philips.com>

IMPORTANT SAFETY INSTRUCTIONS

1. **Read these instructions.**
2. **Keep these instructions.**
3. **Heed all warnings.**
4. **Follow all instructions.**
5. **Do not use this apparatus near water.**
6. **Clean only with dry cloth.**
7. **Do not block any ventilation openings. Install in accordance with the manufacturer's instructions.**
8. **Do not install near any heat sources** such as radiators, heat registers, stoves, or other apparatus (including amplifiers) that produce heat.
9. **Do not defeat the safety purpose** of the polarized or grounding-type plug. A polarized plug has two blades with one wider than the other. A grounding type plug has two blades and a third grounding prong. The wide blade or the third prong are provided for your safety. If the provided plug does not fit into your outlet, consult an electrician for replacement of the obsolete outlet.
10. **Protect the power cord** from being walked on or pinched, particularly at plugs, convenience receptacles, and the point where they exit from the apparatus.

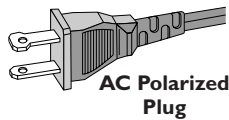

11. **Only use attachments/accessories** specified by the manufacturer.
12.  **Use only with the cart,** stand, tripod, bracket, or table specified by the manufacturer or sold with the apparatus. When a cart is used, use caution when moving the cart/apparatus combination to avoid injury from tip-over.
13. **Unplug this apparatus** during lightning storms or when unused for long periods of time.
14. **Refer all servicing** to qualified service personnel. Servicing is required when the apparatus has been damaged in any way, such as power-supply cord or plug is damaged, liquid has been spilled or objects have fallen into the apparatus, the apparatus has been exposed to rain or moisture, does not operate normally, or has been dropped.
15. **Battery usage CAUTION** – To prevent battery leakage which may result in bodily injury, property damage, or damage to the unit:
 - Install **all** batteries correctly, **+** and **-** as marked on the unit.
 - Do not mix batteries (**old** and **new** or **carbon** and **alkaline**, etc.).
 - Remove batteries when the unit is not used for a long time.
16. **Apparatus shall not be exposed to dripping or splashing.**
17. **Do not place any sources of danger on the apparatus** (e.g. liquid filled objects, lighted candles).
18. This product may contain lead and mercury. Disposal of these material may be regulated due to environment considerations. **For disposal or recycling information, please contact your local authorities or the Electronic Industries Alliance: www.eiae.org.**

EL 6475-E005: 04/01

Class II equipment symbol



This symbol indicates that the unit has a double insulation system.

Canada

English:

This digital apparatus does not exceed the Class B limits for radio noise emissions from digital apparatus as set out in the Radio Interference Regulations of the Canadian Department of Communications.

Français:

Cet appareil numérique n'émet pas de bruits radioélectriques dépassant les limites applicables aux appareils numériques de Classe B prescrites dans le Règlement sur le Brouillage Radioélectrique édicté par le Ministère des Communications du Canada.

CAUTION

Use of controls or adjustments or performance of procedures other than herein may result in hazardous radiation exposure or other unsafe operation.

The unit complies with the FCC-Rules, Part 15 and with 21 CFR 1040.10. Operation is subject to the following two conditions:

1. This device may not cause harmful interference, and

2. This device must accept any interference received, including interference that may cause undesired operation.

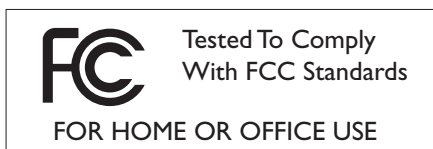

This equipment has been tested and found to comply with the limits for a Class B digital device, pursuant to Part 15 of the FCC Rules. These limits are designed to provide reasonable protection against harmful interference in a residential installation. This equipment generates, uses, and can radiate radio frequency energy and, if not installed and used in accordance with the instructions, may cause harmful interference to radio communications. However, there is no guarantee that interference will not occur in a particular installation. If this equipment does cause harmful interference to radio or television reception, which can be determined by turning the equipment off and on, the user is encouraged to try to correct the interference by one or more of the following measures:

- Reorient or relocate the receiving antenna.
- Increase the separation between the equipment and the receiver.
- Connect the equipment into an outlet on a circuit different from that to which the receiver is connected.
- Consult the dealer or an experienced radio/TV technician for help.

Important safety instructions — 3

General information

Supplied accessories	7
Setup	7
Maintenance	7
Disc handling	7
Environmental information	7

Remote control

Inserting the batteries	8
Using the remote control	8
Using the remote control to control a Philips TV	8

Controls — 10

Connections — 11

Connecting ...

Assembling of the speakers	12
Attaching the front speakers to the subwoofers	12
Attaching the mini speaker stands to the rear speakers	12
Attaching the rear speakers to the wall	12
Positioning of the speakers and the subwoofers	12
Connecting the speakers and the subwoofers	13
How to use the click fit connectors	13
Connecting the tuner antennas	13
Connecting the FM antenna	13
Connecting the AM antenna	13
Connecting the TV	14
Using Component Video (P _R P _B Y)	14
Using Composite Video (CVBS)	14
Using S-Video	14
Connecting audio equipment	15
Connections for playback	15
Connection for digital or analog recordings	15
Connecting to power supply	16
Switching on the system	16
Selecting a source	16
Switching to Eco Power standby	16

Settings for the TV

Check if you see a picture	17
No picture or distorted picture	17
TV Shape	17

Using the System Menu — 18

Volume and sound

Adjusting the Volume	19
Adjusting Bass, Treble, Loudness and ClearVoice	19
Listening through Headphones	19
Adjusting the Surround Sound	19

Internet and PC Link

General information on INTERNET and PC LINK	20
Requirements to use Internet media services	20
Requirements to use PC LINK	20
How to ensure a good wireless connection	20
Network name (SSID)	20
WEP encryption	20
Before connecting	21
A) Wireless home network with wireless router	21
B) PC with a wireless network card or with a wireless USB adapter	23
C) Wired home network with a router	24
D) PC only with a network interface (Ethernet) card	25
Registration	26
About "My.Philips.com"	26
Reviewing and changing network settings	26
Internet services	27
PC LINK	27
Using the colored multifunction buttons – SUBTITLE, ANGLE, ZOOM and AUDIO INFO!	28
FAVORITES	28
Adding a service to your favorites	28
Accessing your favorites	28
Recently used media services – RECENT	29
Multiple users – USER	29
Adding a new user	29
Selecting a user	29
Removing a user	29

Disc

General Information	30
Playable Discs	30
Region Codes	30
Available disc Features	30
Disc Playback	31
Selecting next disc	31
Resume	31
Chapter Preview	31
Chapter/track selection	32
Forward and Reverse Searching	32
Searching in the System Menu	32
Time Search	32
Fast, Slow	33
Still Picture/Frame-by-Frame Playback	33

Contents

Disc

Repeat	33
Shuffle	33
Program	34
Programming tracks/chapters/titles	34
Playing a program	34
Reviewing / Deleting programmed tracks	34
Clearing the entire program	34
Disc Menu	35
Audio	35
Subtitles	35
Camera Angle	35
Zoom	35
Selecting the menu language, country, audio language and subtitle language	36
Menu Language	36
Country	36
Default Audio	36
Default Subtitle	36
Playback Control (PBC)	36
Switching PBC on/off	36
Playing a (Super) Video CD with PBC	36
Playing MP3 discs	37
Playing picture CDs	38
Rotating a picture	38
Playing a slide show	38

Access Control 39

Parental Level	39
Change Pin	39
Disc Lock	39
If you forget your Pin	39

System Menu – Picture settings

Adjusting the Picture Settings	40
Color Settings	40
Brightness	40
Contrast	40
Sharpness	40
Saturation	40
Video Shift	40

System Menu – Audio settings

Night Mode	41
Analogue Output	41
Digital Output	41
Speaker layout, speaker distances and volume balance	42

System Menu – Additional features

Help Line and Status window	43
Sleep timer	43
Adjusting the display brightness	43
Online upgrade	43
Resetting the Streamium System	43

Tuner

Tuning to radio stations	44
Automatic Preset Programming	44
Storing favorite radio stations manually	44
Selecting a favorite radio station	44
Deleting a favorite radio station	45
Deleting all favorite radio stations	45
Changing the order of favorite radio stations	45

Troubleshooting 46–48

Technical data 49

Warranty 50

Supplied accessories

Your Streamium DVD System is delivered with:

- 2 front, 1 center and 2 rear speakers
- 2 subwoofers built into the speaker stands
- 7 speaker cables
- 1 RCA-style audio cable (white and red plugs)
- 1 Composite Video (CVBS) cable (yellow)
- 1 Component Video cable (red/blue/green)
- 1 FM antenna
- 1 AM loop antenna
- 1 AC power cable
- 1 Category 5 Ethernet cable
- 1 remote control
- 2 batteries type AA

Setup

Place the unit on a flat, hard, and stable surface. Do not place the unit on a carpet.

Do not position the unit on top of other equipment that might heat it up (e.g. receiver or amplifier).

Do not put anything under the unit (e.g. CDs, magazines).

Allow at least 10 cm clearance from the rear and top of the unit and 5 cm from the left and right to prevent overheating.

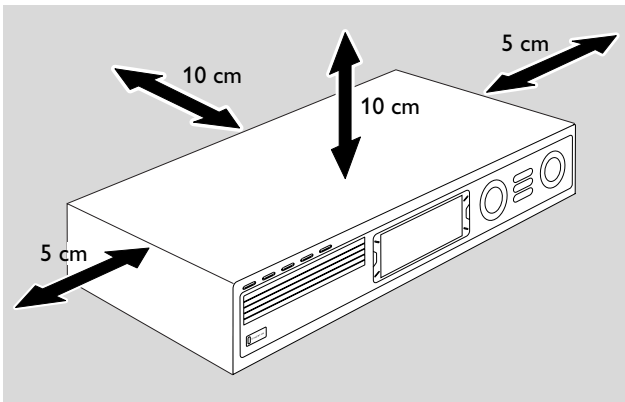

Do not block the ventilation openings.

Do not expose the unit to dripping or splashing.

Do not place any sources of danger (e.g. liquid filled objects, lighted candles) on the unit.

Active mobile phones near the unit may cause malfunctions.

Maintenance

Clean the unit with a soft, slightly dampened, lint-free cloth. Do not use any cleaning agents as they may have a corrosive effect.



Do not expose the unit, batteries or discs to humidity, rain, sand or excessive heat (caused by heating equipment or direct sunlight).

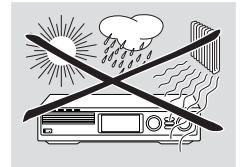

Always keep the trays of your unit closed to protect the lens from dust. Do not use any commonly available lens cleaning discs, as they may damage the optical lens of the unit.

The lens may cloud over when the unit is moved from cold to warm surroundings. Playing a disc is not possible then. Leave the unit in a warm environment until the moisture evaporates.

Disc handling

To take a disc out of its box easily, press the center spindle while lifting it. Always hold a disc by the edge and put it back in its box after use.

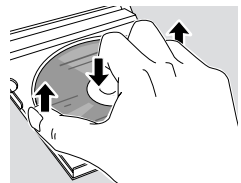

Never attach a sticker to a disc. If you want to label a disc, use a soft, felt-tipped pen and write only on the printed side.

To clean a disc, wipe it in a straight line from the center toward the edge using a soft, lint-free cloth. Any cleaning agents may damage the disc!

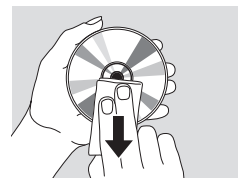

Environmental information

All redundant packing material has been omitted. We have tried to make the packaging easy to separate into three single materials: cardboard (box), polystyrene foam (buffer) and polyethylene (bags, protective foam sheet).

Your unit consists of materials which can be recycled if disassembled by a specialized company. Please observe the local regulations regarding the disposal of packing materials, dead batteries and old equipment.

Remote control

Inserting the batteries

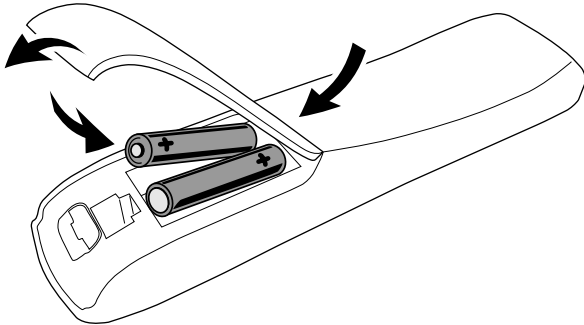

- 1 Open the battery compartment of the remote control.
- 2 Insert two alkaline batteries, type **AA** (R06, UM-3), according to the + and – indications.
- 3 Close the battery compartment.

Do not combine old and new or different types of batteries.

Remove batteries if they are discharged or if the remote control will not be used for a long time.

Batteries contain chemical substances, so they should be disposed of properly.

Using the remote control

- 1 Aim the remote control directly at the remote sensor of the Streamium System.
- 2 Select the source you wish to control by pressing one of the source buttons on the remote control, e.g. TV, TUNER.
- 3 Next, select the desired function, e.g. ►OK.







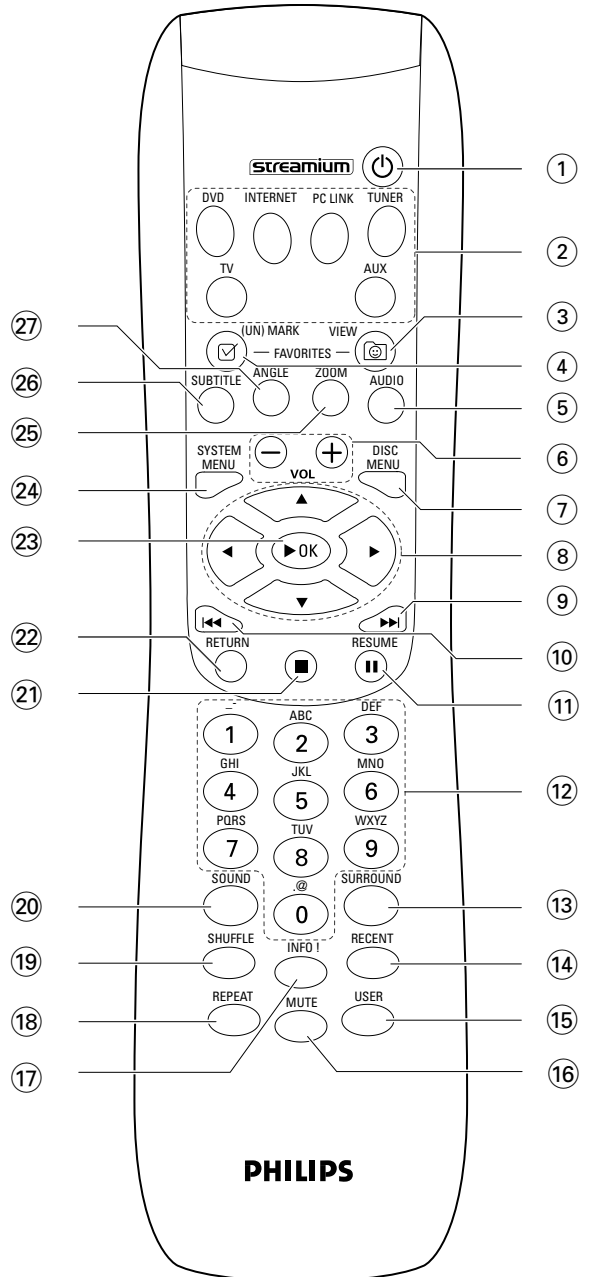

Using the remote control to control a Philips TV

When TV is selected, the remote control will control some functions on your Philips TV, e.g.

- 0–9 select a TV channel.
- SYSTEM MENU switches the system menu of the TV on/off.
- ◀, ▶, ▲, ▼ navigate in the system menu.
- ◀◀, ▶▶ select the previous/next TV channel.
- ■ exits the system menu of the TV.
- MUTE mutes the sound on the TV.
- INFO! switches TV text on/off.

To control the TV, aim the remote control directly at the TV.



- ①  switches the unit to standby (off). To activate the unit, press any source button.
- ② **source buttons**
INTERNET connects to the Internet
PC LINK connects to the PC
DVD selects discs 1–5. Press repeatedly.
TV plays the TV sound on the Streamium System.
TUNER selects FM or AM radio. Press repeatedly.
AUX selects AUX DIGITAL or AUX ANALOG. Press repeatedly.
- ③  **VIEW FAVORITES**
INTERNET, TUNER: shows your favorite Internet media services and radio stations
- ④  **(UN)MARK FAVORITES**
INTERNET, TUNER: marks and unmarks favorites
- ⑤ **AUDIO (blue button)**
DVD: selects an audio channel (e. g. a different language) during playback of a DVD or (Super) Video CD
INTERNET, PC LINK: multifunction button
- ⑥ **VOL+, -**
adjust the volume
- ⑦ **DISC MENU**
enters and exits the disc menu (DVD)
- ⑧ 
moves the cursor left, right, up or down in the menus
TUNER: ▲, ▼ selects favorite radio stations,
◀, ▶ tunes to a radio station, press for 1 second to auto search for a radio station.
- ⑨ 
DVD: skips to the beginning of the next chapter/title/track of a disc; searches forward if pressed longer than 2 seconds. Press again for various search speeds.
TV: selects a higher channel.
- ⑩ 
DVD: skips to the beginning of the current or previous chapter/title/track of a disc; searches backward if pressed longer than 2 seconds. Press again for various search speeds.
TV: selects a lower channel.
- ⑪ **II**
pauses playback
- ⑫ **0–9** to enter numbers 0–9 and characters (to enter a number with two or more digits, press 0–9 repeatedly within 2 seconds)
- ⑬ **SURROUND**
selects the different sound settings: multi-channel surround, Hall or stereo mode.
- ⑭ **RECENT**
INTERNET, PC LINK: displays the last 20 items played
- ⑮ **USER**
selects an active user
- ⑯ **MUTE**
switches the speakers' sound off or on again.
TV: switches the sound on the TV off/on.
- ⑰ **INFO!**
INTERNET, PC LINK: requests on-line information about currently playing item through e-mail (if available).
- ⑱ **REPEAT**
selects the different repeat modes (depending on the media type); switches repeat mode off.
- ⑲ **SHUFFLE**
plays tracks in random order
- ⑳ **SOUND**
selects a different sound setting for bass, treble, loudness and clearvoice.
- ㉑ 
stops playback.
- ㉒ **RETURN**
returns to the previous menu.
- ㉓  **OK**
starts playback, resumes playback, or confirms a selection.
- ㉔ **SYSTEM MENU**
DVD, INTERNET, PC LINK, AUX: enters the system menu.
- ㉕ **ZOOM (yellow button)**
shows a close up view of a particular portion of the picture on the TV screen,
INTERNET, PC LINK: multifunction button
- ㉖ **SUBTITLE (red button)**
switches on or off the subtitles of a DVD during playback
INTERNET, PC LINK: multifunction button
- ㉗ **ANGLE (green button)**
selects the camera angle (if available) of a DVD during playback
INTERNET, PC LINK: multifunction button

Controls

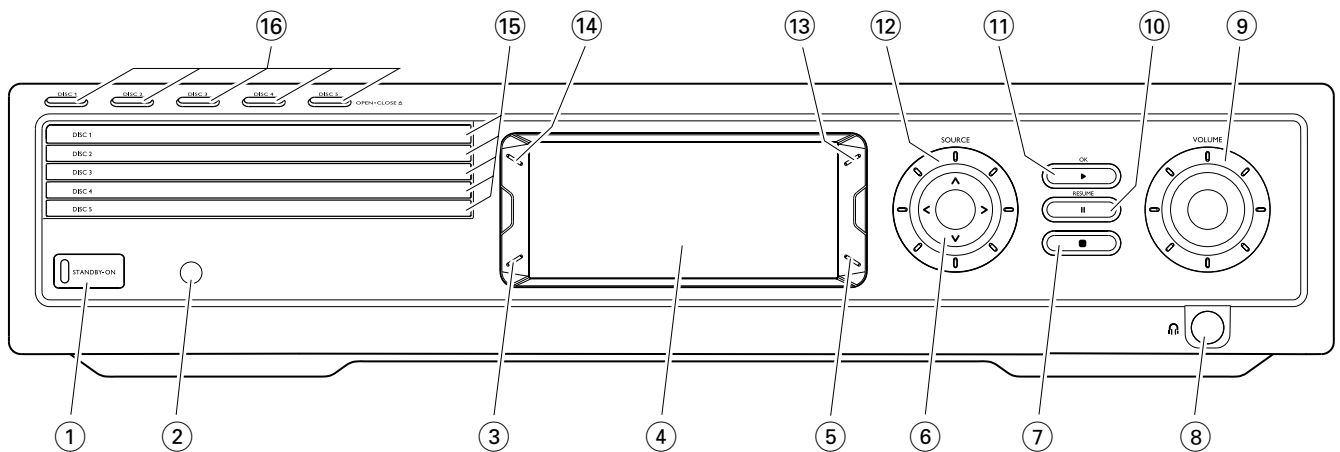

- ① **STANDBY-ON**
switches the unit on or to standby (off)
- ② IR sensor for the remote control
- ③ INTERNET, PC LINK: multifunction button (same function as red button on the remote control)
- ④ display
- ⑤ INTERNET, PC LINK: multifunction button (same function as green button on the remote control)
- ⑥ < > ^ v
moves left, right, up or down in the menus, selects favorite radio stations
- ⑦ ■
stops playback
- ⑧ 6.3 mm headphones jack
- ⑨ **VOLUME**
adjusts the volume
- ⑩ **II**
pauses playback
- ⑪ **▶OK**
starts playback, resumes playback, or confirms a selection
- ⑫ **SOURCE**
selects a source (DISC 1–5, TV, TUNER, AUX DIGITAL, AUX ANALOG, INTERNET, PC LINK)
- ⑬ INTERNET, TUNER: shows your favorite Internet media services and radio stations
- ⑭ (same function as RECENT on the remote control)
INTERNET, PC LINK: displays the last 20 items played
- ⑮ disc trays 1–5
- ⑯ **DISC 1–5, OPEN·CLOSE ▲**
opens/closes disc trays 1–5

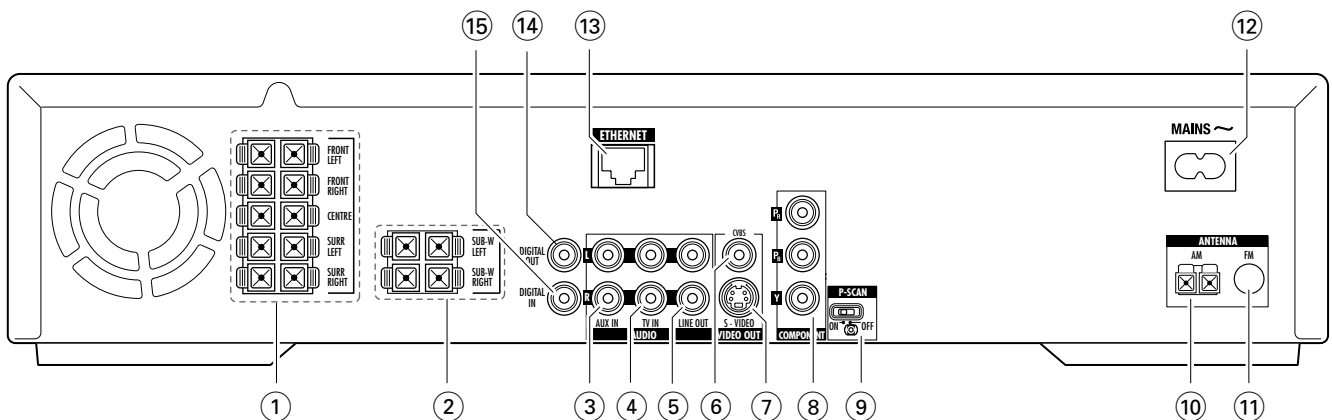

① FRONT LEFT, FRONT RIGHT, CENTRE, SURR LEFT, SURR RIGHT

FRONT LEFT: connect the front left speaker
 FRONT RIGHT: connect the front right speaker
 CENTRE: connect the center speaker
 SURR LEFT: connect the surround left speaker
 SURR RIGHT: connect the surround right speaker

② SUB-W LEFT, SUB-W RIGHT

connect the left and right subwoofers

③ AUX IN L, R

connect to the left and right analog audio output jacks of external equipment (e. g. tape deck, VCR, ...)

④ TV IN L, R

connect to the left and right AUDIO OUT jacks of the TV

⑤ LINE OUT L, R

connect to the left and right analog audio input jacks of an external equipment (e. g. tape deck, ...)

⑥ VIDEO OUT/CVBS

connect to the Composite Video input of the TV

⑦ VIDEO OUT/S-VIDEO

connect to S-Video input of the TV

⑧ COMPONENT P_R, P_B, Y

connect to the corresponding Component video inputs of the TV

⑨ P-SCAN

to switch on or off progressive scan

⑩ ANTENNA / AM

connect the AM loop antenna

⑪ ANTENNA / FM

connect the FM antenna cable

⑫ MAINS ~

After all other connections have been made, connect the power cable to the power outlet.

⑬ ETHERNET

connect to router, broadband Internet, or PC

⑭ DIGITAL OUT

connect to the digital coaxial input of digital equipment

⑮ DIGITAL IN

connect to the digital coaxial output of digital equipment

Before starting with the connections, make sure all equipment you want to connect – as well as the Streamium System – are disconnected from the power outlets.

Connecting ...

Before you make connections, make sure the unit is not connected to the power supply.

Assembling of the speakers

You can use the subwoofers as speaker stands for the front or for the rear speakers. The following text describes the setup of the subwoofers in the front.

Attaching the front speakers to the subwoofers

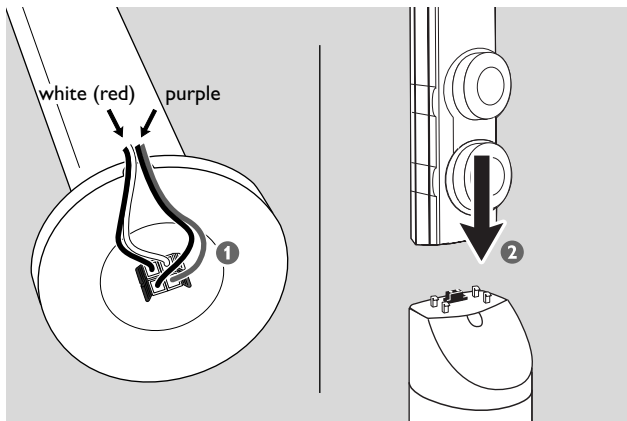

- 1 Connect the speaker cables to the connectors on the bottom of the subwoofers before attaching the front speakers.
- 2 Put the front speakers on top of the subwoofers and press them down gently until you hear a "click."
→ The front speakers are now connected to the subwoofers.
- 3 Next, attach the rear speakers to the wall or use the supplied mini speaker stands.

Attaching the mini speaker stands to the rear speakers

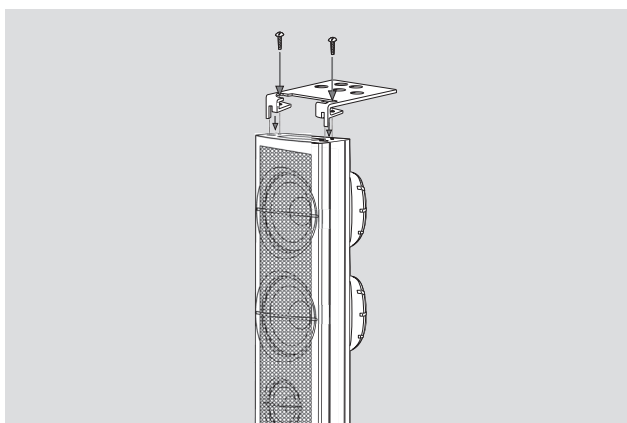

- Attach a supplied speaker stand firmly to the bottom of each rear speaker using the supplied screws.

Attaching the rear speakers to the wall

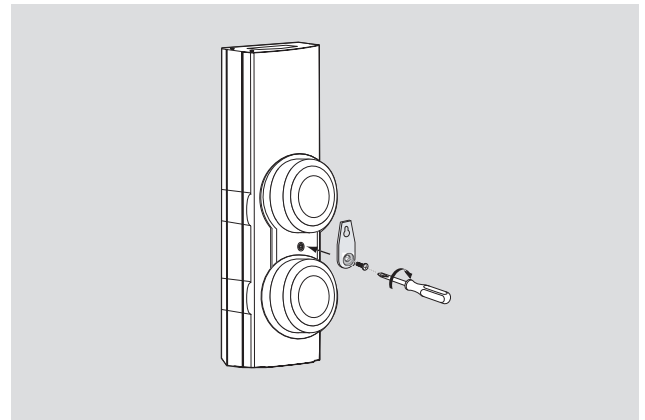

- 1 Attach the supplied bracket firmly to the rear of the rear speaker using the supplied screws.
- 2 Hook the speaker carefully onto a screw in the wall, using the hole in the bracket.

Positioning of the speakers and the subwoofers

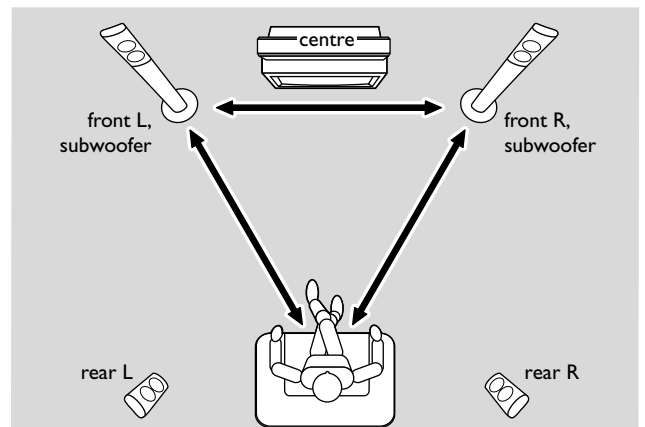

- 1 Place the subwoofers with the front speakers at an equal distance to your TV. The distance between your listening position and the left and right front speakers should be approximately equal to the distance between the left and right front speakers.
- 2 Place the center speaker on top of the TV.
- 3 Place the left and right rear speakers to the left and right of your preferred listening position.

Notes:

Keep the speakers away from the room's corners.

Position the speakers at ear level.

Leave enough space between the left and right front speakers and the TV to avoid magnetic interference.

Connecting the speakers and the subwoofers

We recommend connecting all speakers. **At least the front speakers (left and right) and the subwoofers must be connected.** If you do not connect all speakers, press SURROUND repeatedly to select STEREO after switching on the Streamium System.

When connecting the speakers make sure the colors of the speaker cables correspond with the colors of the connectors.

- 1 Insert the supplied speaker cables into the click-fit connectors on the speakers.
- 2 Then connect the speaker cables to the corresponding click-fit connectors on the rear of the unit so that the colors of the speaker connectors and the speaker cables match.

Speaker	+	-
Front Left	white	black
Front Right	red	black
Center	green	black
Surround Left	blue	black
Surround Right	grey	black
Subwoofer Left	purple	black
Subwoofer Right	purple	black

How to use the click fit connectors

- 1 Press down the clip and fully insert the stripped portion of the speaker cable into the socket.
- 2 Release the clip again.

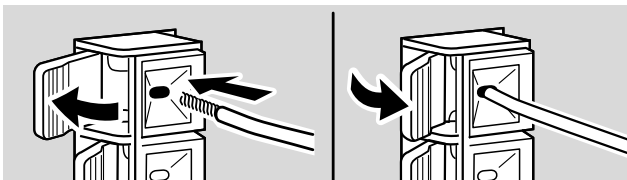

Connecting the tuner antennas

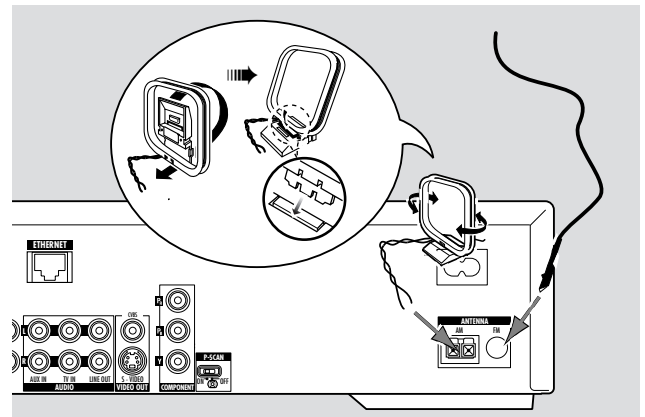

Connecting the FM antenna

- 1 Connect the supplied FM antenna cable to the FM ANTENNA jack on the rear of the unit.
- 2 Extend the antenna cable and put it in a position where the reception is best.

Connecting the AM antenna

- 1 Assemble the supplied AM loop antenna as shown above.
- 2 Connect the antenna to the AM ANTENNA jack on the rear of the unit.
- 3 Place the antenna on a shelf or mount it on the wall in a position where the reception is best.

Connecting ...

Connecting the TV

After connecting the speakers, choose one of several kinds of video connections, which differ in quality. For the availability of the necessary connectors on your TV, please read the user's manual of your TV.

You only need one video connection between the TV and the Streamium System (Component Video, S-Video, or Composite Video).

S-Video or Component Video provides better picture quality than Composite Video. To use these connections, these options must be available on your TV.

Connect the Streamium System directly to the TV.

Using Component Video (P_R P_B Y)

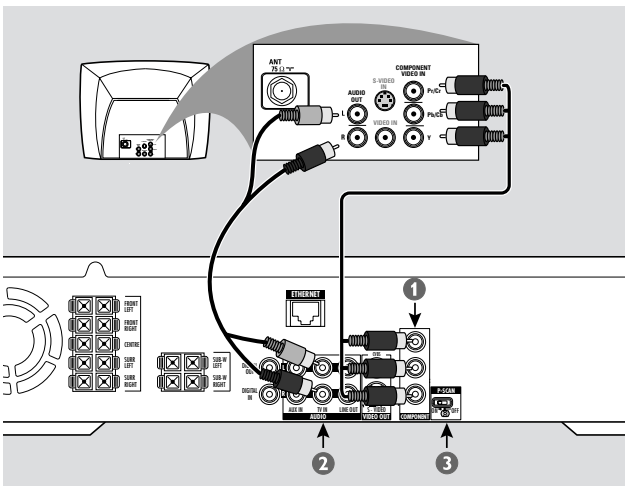

- 1 Use the component video cables (red/blue/green) to connect the Streamium System's COMPONENT P_R P_B Y jacks to the corresponding Component Video Input jacks (or labelled as Pr/Cr Pb/Cb Y or YUV) on the TV.
- 2 To hear the sound of the TV through this Streamium System, use the audio cables (white/red) to connect TV IN (L/R) jacks to the corresponding AUDIO OUT jacks on the TV.
- 3 If you are using a Progressive Scan TV (TV must indicate Progressive Scan or ProScan capability,) set the P-SCAN switch (at the rear of the Streamium System) to ON. Otherwise, set it to OFF.

Notes:

To set Video Output to 'Y P_B P_R', change the setting manually in the System Menu. See chapter "No picture or distorted picture."

The progressive scan video quality is only possible through the COMPONENT P_R P_B Y output.

Using Composite Video (CVBS)

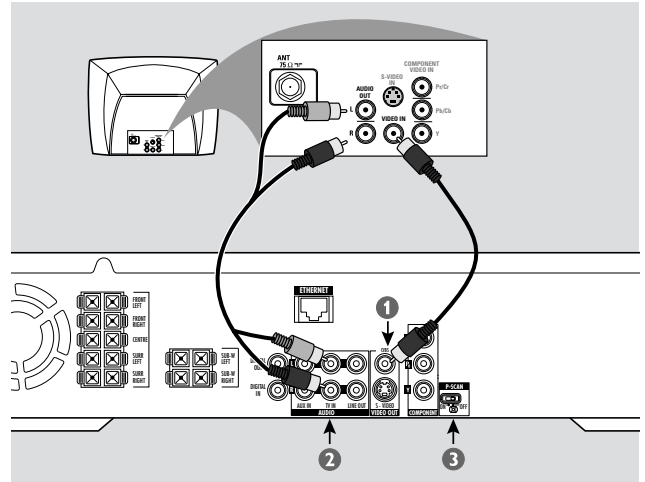

- 1 Use the composite video cable (yellow) to connect the Streamium System's CVBS jack to the video input jack (or labelled as A/V In, Video In, Composite) on the TV.
- 2 To hear the sound of the TV through this Streamium System, use the audio cable (white/red) to connect TV IN (L/R) on the Streamium System to the corresponding AUDIO OUT jacks on the TV.
- 3 Set the P-SCAN switch to OFF.

Using S-Video

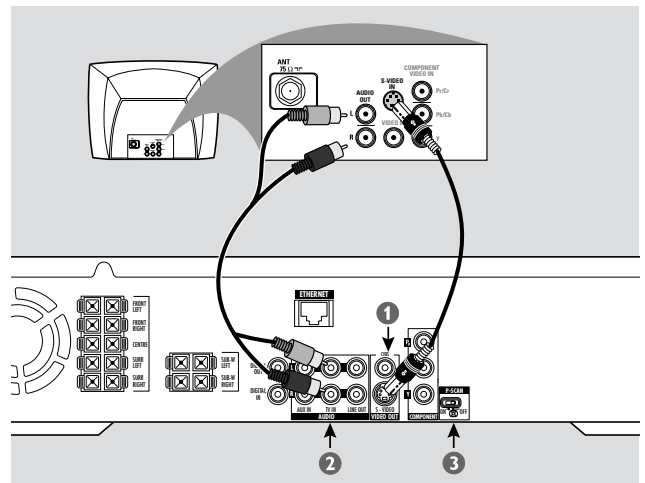

- 1 Use an S-Video cable (not supplied) to connect the Streamium System's S-VIDEO jack to the S-Video input jack (or labelled as Y/C or S-VHS) on the TV.
- 2 To hear the sound of the TV through this Streamium System, use the audio cable (white/red) to connect TV IN (L/R) on the Streamium System to the corresponding AUDIO OUT jacks on the TV.
- 3 Set the P-SCAN switch to OFF.

Connecting audio equipment

Connections for playback

To play the sound of additional audio equipment on the Streamium System, one digital and one analog connection are available.

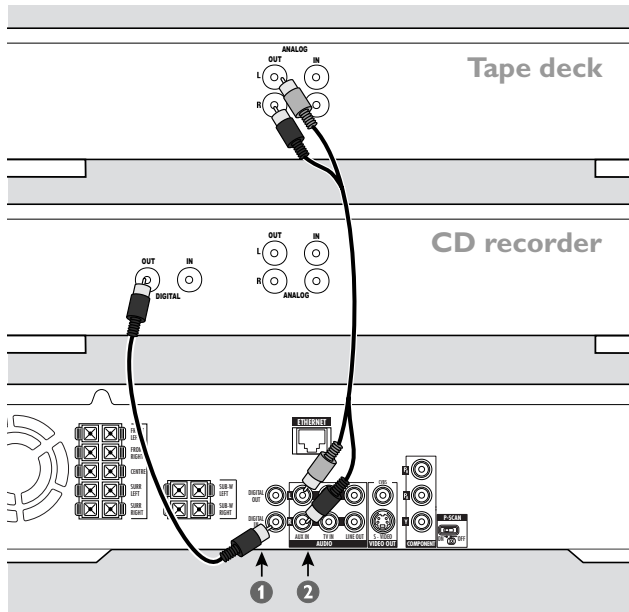

- 1 Connect a digital RCA-style cable to the DIGITAL IN of the Streamium System and to the digital output jack of the digital equipment.
- 2 Connect an RCA-style audio cable to AUX IN (L/R) on the Streamium System and to the left and right analog output jacks of your tape deck, CD player; or similar.

Notes:

To use these connections, press **AUX** on the remote control repeatedly (or rotate **SOURCE** on the Streamium System) to select **AUX DIGITAL** or **AUX ANALOG**.

You cannot connect a turntable to AUX IN.

Connection for digital or analog recordings

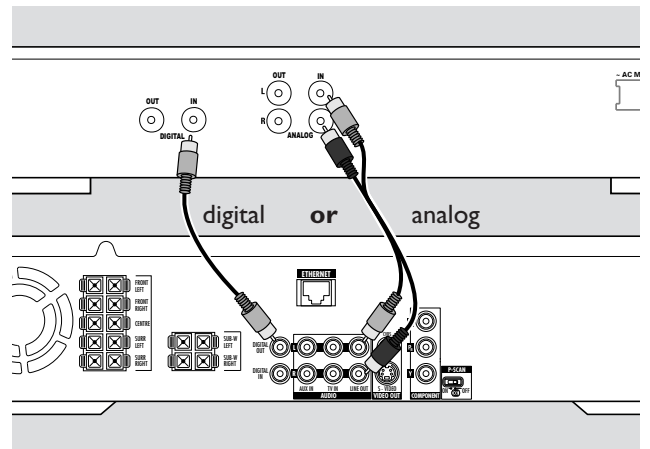

- To record the sound from the Streamium System to a digital system, connect a digital RCA-style cable to DIGITAL OUT on the Streamium System and to the DIGITAL IN jack of the digital equipment.
- When digital recording is not permissible, record the analog sound from the Streamium System. Use the audio cable (white/red) to connect LINE OUT (L/R) on the Streamium System to the corresponding AUDIO IN (L/R) jacks on the digital equipment.
- Refer to the Instruction Manual of the digital equipment on recording.

Recording is permissible insofar as copyright or other rights of third parties are not infringed upon.

When playing an MP3-CD on the Streamium System, no signal will be available using DIGITAL OUT.

This product incorporates Macrovision copyright protection technology that is protected by US patent no. 4631603, 4577216 and 4819098, as well as other intellectual property rights. Use of this copyright protection technology must be authorized by Macrovision Corporation, and is only intended for home use and other pay-per-view applications. Macrovision must provide written authorization for any other use. Change to the device, reverse engineering or disassembly is prohibited.

Connecting ...

Connecting to power supply

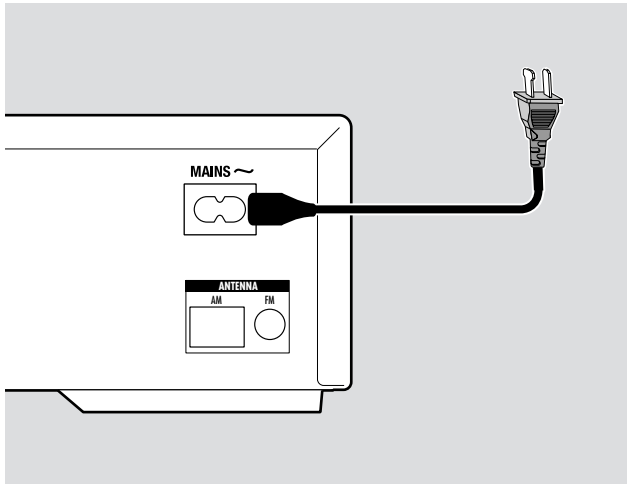

The type plate is located on the rear of the unit.

- 1 Check whether the power voltage as shown on the type plate corresponds to your local power voltage. If it does not, consult your dealer or service organization.
- 2 Make sure your TV is switched off before connecting the Streamium System to the power supply for the first time.
- 3 **Make sure all connections have been made before switching on the power supply.**
- 4 Connect the supplied power cable to MAINS ~ at the rear of the Streamium System and to the power outlet.

When the unit is switched to standby (off), it is still consuming some power. **To disconnect the unit from the power completely, remove the power plug from the wall outlet.**

To avoid overheating of the unit, a safety circuit has been built in. Therefore your unit may disconnect under extreme conditions. If this happens, unplug the unit and let it cool down before reusing it.

Switching on the system

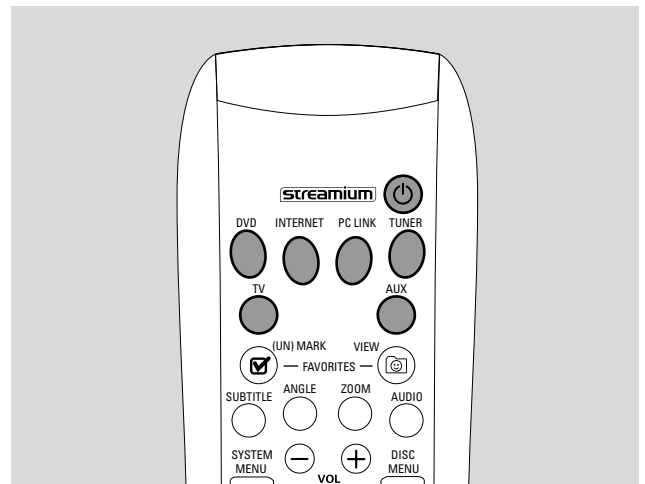

- Press STANDBY-ON on the Streamium System or one of the source buttons on the remote control (DVD, TV, TUNER, AUX, INTERNET, PC LINK) to switch on the Streamium System.

Selecting a source

- Turn SOURCE on the Streamium System or press DVD, INTERNET, PC LINK, TUNER, TV or AUX on the remote control to select a source.
 - The selected source will be displayed.

On the remote control:

- To select disc 1, 2, ... 5, press DVD repeatedly.
- To select equipment connected to AUX IN or DIGITAL IN on the Streamium System, press AUX repeatedly.

Switching to Eco Power standby

- Press STANDBY-ON on the Streamium System or  on the remote control.
 - The STANDBY-ON button will light up on the system.
 - The display screen will go blank.

Note: The Streamium System will switch to Standby automatically after 20 minutes of no activities, if "Sleep timer" is switched on in the System Menu and if DVD or INTERNET is selected.

The following settings optimize the connection between the Streamium System and the TV.

Check if you see a picture

- 1 Switch on your TV.
- 2 Press AUX on the remote control.
- 3 Next, press SYSTEM MENU on the remote control.
- 4 If necessary set the TV to the correct audio/video channel for the Streamium System. Such channels may be called AUX or AUXILIARY IN, AUDIO/VIDEO or A/V IN, EXT1, EXT2 or EXTERNAL IN, etc. These channels are often near channel 00. If you are using an RF modulator, select the channel for the RF modulator:
→ The system menu of the Streamium System should appear on the TV.

No picture or distorted picture

The Streamium System may be set to the wrong video signal. Observe the display on the Streamium System.

- 1 If necessary, press AUX on the remote control. Next, press SYSTEM MENU.
- 2 Press ▼ repeatedly to select PICTURE. Next press ►.
- 3 Press ▼ repeatedly to select TV SETTINGS. Next, press ►.
- 4 Press ▼ repeatedly to select VIDEO OUTPUT. Next, press ►.
- 5 Press ▼ or ▲ repeatedly to select
 - Y PB PR (COMPONENT VIDEO) if you have connected the TV to COMPONENT P_R P_B Y on the Streamium System,
 - CVBS if you have connected the TV to CVBS or S-Video on the Streamium System.
- 6 Press ►OK to confirm the setting.
- 7 Next, press SYSTEM MENU to exit the system menu.

TV Shape

You may set the Streamium System to display a DVD movie in one of three formats: Letterbox, Panscan, or Widescreen. The TV Shape you select must be supported by the movie. If not, the TV Shape settings will not affect the picture.

- 1 Press SYSTEM MENU on the remote control.
- 2 DVD: Use ◀, ▶, ▲ or ▼ to select **Setup → TV → TV Shape**.
INTERNET, PC LINK, AUX: Use ◀, ▶, ▲ or ▼ to select **Picture → TV Settings → TV Shape**.

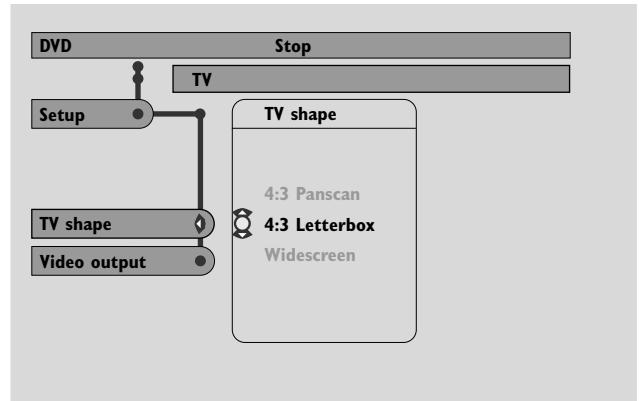

- 3 Press ► to enter the menu and ▼ to select

- **4:3 Letterbox** if you have a regular TV and the picture will have black bars at the top and bottom of the screen,

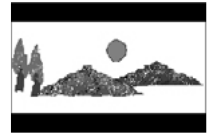

- **4:3 Panscan** if you have a regular TV and both sides of the picture will be trimmed to fit your TV screen,

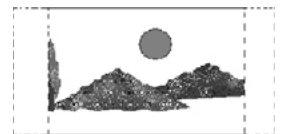

- **Widescreen** if you have a widescreen TV.

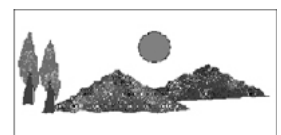

Note: Some widescreen TVs may show only part of the System Menu. This is not an error of the Streamium System settings. Adjust the screen mode on your TV. See your TV owner's manual for details.

Using the System Menu

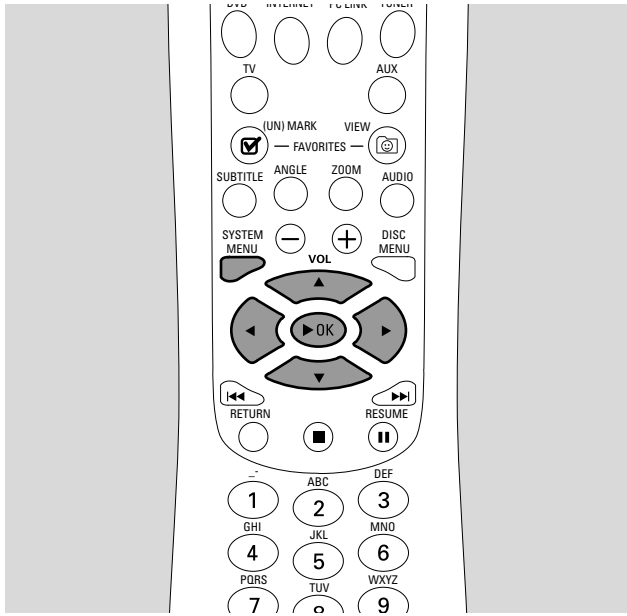

The System Menu allows you to operate features available in this Streamium System.

Please be aware that the System Menu and the available features in the menu depend on the selected source. Even though the System Menus of DVD and INTERNET/PC LINK look different, many features (e. g. color settings, parental control, etc.) are available in both menus and work similarly.

Most of the illustrations in this manual show the System menu when DVD is selected.

- 1** Press SYSTEM MENU on the remote control to enter the System menu.
 - 2** Press ◀, ▶, ▲, ▼ on the remote control to navigate in the menu, to select a feature or to change the setting of a feature.
 - 3** Press ▶OK to confirm a setting.
- To exit the System Menu press SYSTEM MENU.

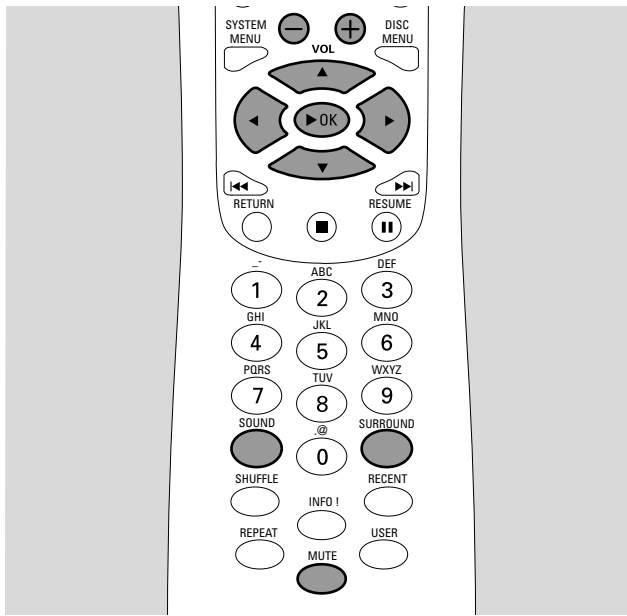

Adjusting the Volume

- Turn VOLUME on the Streamium System or press VOL+ or VOL- on the remote control to adjust the volume.
→ The volume setting will be displayed.
- To switch off the sound, press MUTE on the remote control.
- To switch the sound on again, press MUTE again.

Note: When TV is selected, MUTE will switch off the sound on your Philips TV.

Adjusting Bass, Treble, Loudness and ClearVoice

- 1 Press SOUND on the remote control repeatedly to select BASS, TREBLE, LOUDNESS or CLEARVOICE.
- 2 Bass or Treble: Within 3 seconds, press ◀, ▶, ▲ or ▼ to adjust the level of bass/treble.

Loudness or ClearVoice: Within 3 seconds, press ◀, ▶, ▲ or ▼ to switch Loudness/ClearVoice on or off.
- 3 Press ▶OK on the remote control to confirm.

Note: ClearVoice enhances the voices in surround sound signals to make dialogues easier to follow. ClearVoice is available for surround sounds only.

Listening through Headphones

- Connect the headphones plug (6.3mm) to the headphones jack (🎧) on the Streamium System.
→ The sound on all the speakers will be muted.

Adjusting the Surround Sound

To have optimum surround sound ensure that all the speakers and subwoofers are connected properly.

The available multi-channel sounds include: DTS (Digital Theater Systems) Surround, Dolby Digital, Dolby Surround and Dolby Pro Logic 2.

A surround sound effect will only be available if it is supported by the disc, the media file, or the media service you are playing.

The number of speakers that play a sound depends on the selected surround sound and the sound available on the disc (e.g. when Stereo is selected, only the front left and right speakers and the subwoofers will operate).

- Press SURROUND on the remote control repeatedly to select STEREO, MULTI-CHANNEL (DTS and DOLBY) or HALL.
→ The selected sound will be displayed.

Notes:

You can also set the Surround sound in the System Menu. See "Analogue output."

If you have not connected all speakers, press SURROUND repeatedly to select STEREO.

Manufactured under license from Dolby Laboratories. "Dolby", "Pro Logic", and the double-D symbol are trademarks of Dolby Laboratories.



Manufactured under license from Digital Theater Systems, Inc. US Pat. No. 5,451,942, 5,956,674, 5,974,380, 5,978,762 and other world-wide patents issued and pending. "DTS" and "DTS Digital Surround" are registered trademarks of Digital Theater Systems, Inc. Copyright 1996, 2000 Digital Theater Systems, Inc. All Rights reserved.



Internet and PC Link

General information on INTERNET and PC LINK

This Philips Streamium System is a wireless broadband Internet system. It is compliant with the IEEE 802.11g standard. The Streamium System can connect to your wireless or wired home network and play various Internet media services (e. g. Internet radio, video ...) as well as media files (music, pictures ...) stored on the PCs of your home network.

The Streamium System is upgradable through your Internet connection. From time to time, new features will be available and the functionality of this Streamium System will change. Therefore, this manual offers only a rough overview of the Internet and PC link functionality.

Please visit "My.Philips.com" for the latest information on available services and new functionality.

Requirements to use Internet media services

- broadband Internet access (DSL, cable modem),
- an email address.

Please ask your Internet service provider

- if you can connect several devices (computers and the Streamium System) to your Internet connection,
- if he allows only devices with registered MAC addresses to connect to the Internet,
- if he charges extra fees for exceeding a certain limit of transferred data. When you use Internet media services on a daily basis, you may exceed such a limit. For example: When you listen to Internet radio (transmitting at 64 kbit/sec) for about 36 hours, 1 GB (Gigabyte) of data will be transferred to your Streamium System.

Requirements to use PC LINK

- a computer with Windows® operating system (Windows 98 SE or higher) or Mac OS® X,
- installation of the Philips Media Manager software on your computer.

The following file formats stored on your computer are supported at the time of printing this manual (subject to change):

- Music: MP3 and MP3pro streams; bit rates: 32–320 kbit/sec, variable bit rate
- Pictures: JPEG, JPEG2000, .bmp, .gif
- Video: MPEG 1, MPEG 2, MPEG 4, DivX® 4.0/5.03

Please visit My.Philips.com for the latest information on supported operating systems and file formats.

How to ensure a good wireless connection

- Place your wireless router as close as possible to the center of the area you want to cover.
- Keep the antenna(s) away from large metal objects to avoid interference.
- Avoid placing the Streamium System close to microwave ovens.
- Avoid placing this Streamium System directly under or above the wireless router.
- Refer to the signal strength indication to locate the best position for the wireless router and the Streamium System. To display the signal strength indication, press SYSTEM MENU and select **Network**. Next, select **Wireless Info → Signal Level**.

Network name (SSID)

The network name (SSID) identifies your computer in a wireless network. Please keep in mind that the network name is case sensitive.

WEP encryption

WEP encryption protects your wireless network against intrusion. WEP encryption uses up to 4 encryption keys to encrypt the data sent in your wireless network.

If you use WEP encryption make sure

- the number and the order of encryption keys on the Streamium System and on your wireless router/wireless network adapter are the same,
- all encryption keys you enter have the same format (either ASCII or HEX format) and the same length (ASCII, either 5 or 13 characters; HEX, either 10 or 26 digits).

Note: Some wireless routers/wireless network adapters allow you to type in a passphrase instead of an encryption key. Do not use passphrases with the Streamium System, since passphrases are not supported.

Windows is a registered trademark of Microsoft Corporation in the United States and other countries.

Mac OS is a registered trademark of Apple Computer, Inc.

DivX® is a registered trademark of DivXNetworks, Inc.

Before connecting

- 1 If you have a wired or a wireless home network and you have not set it up yet, consult the user's manual of your (wireless) router on how to set up the network and how to connect to the Internet.
- 2 Check if the computers in your network connect properly to the Internet and to each other. If you face any problems connecting to the Internet, consult your Internet service provider.
- 3 Install the Philips Media Manager software on the PCs of your network:
Either download the latest version at "My.Philips.com" or install it from the supplied CD-ROM. Please refer to the installation guide of the Media Manager software for installing the software and making media files of your PCs available to the Streamium System.
- 4 Switch on the TV and set the TV to the correct audio/video channel for the Streamium System. Such channels may be called AUX or AUXILIARY IN, AUDIO/VIDEO or A/V IN, EXT1, EXT2 or EXTERNAL IN, etc. These channels are often near channel 00.

Note: If you did not connect the Streamium System to a TV, observe the display on the Streamium System.

- 5 Switch on the Streamium System.
- 6 Depending on your home network, continue with one of the following 4 sections:
 - A) Wireless home network with a wireless router;
 - B) PC with a wireless network card or with a wireless USB adapter;
 - C) Wired home network with a router;
 - D) PC only with a network interface (Ethernet) card.

Check the illustrations at the beginning of each section to find out which of the 4 cases describes your home network best.

A) Wireless home network with wireless router

Follow these instructions if you have

- a wireless router and
- broadband Internet access.

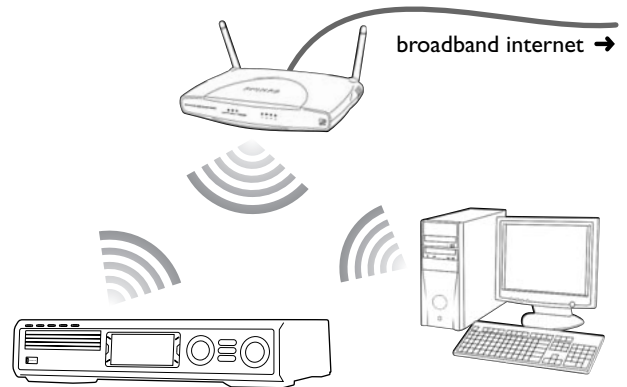

- 1 Press INTERNET on the remote control.
→ The Streamium System tries to connect automatically to a wireless network.
- 2 If the Streamium System connects to a wireless network, it will display its network name (SSID) briefly. **Please verify that the displayed network name corresponds to the network you want to join.** If you want to connect to another network, press SYSTEM MENU and select **Network Settings → Network Config.** to change the wireless network settings.

After connecting to the Internet the Streamium System will ask you to enter your email address. Continue with "Registration."

If the Streamium System fails to connect, read the message on the TV screen and continue with one of the following paragraphs.

If 'Choose your wireless network' appears

Several wireless networks or one encrypted network are available.

- 1 Press ▼ or ▲ repeatedly to select the network you want to join.

If the desired network does not appear, press the red button (SUBTITLE) on the remote control to select **manual** and continue with "If 'Enter wireless network name (SSID)' appears."
- 2 Press the green button (ANGLE) on the remote control to confirm the selected network.
- 3 If the selected network is WEP encrypted, continue with "If the network is WEP encrypted."

If the Streamium System connects to the Internet, continue with "Registration."

Internet and PC Link

If 'Are you using a wireless (WiFi/802.11) or a wired (Ethernet) network connection?' appears

- Press the red button (SUBTITLE) on the remote control to connect to a wireless network.

If 'Enter wireless network name (SSID)' appears

- 1 Press the red button (SUBTITLE) on the remote control to search again for all available networks or, use the number buttons to enter the network name (SSID) of your wireless network.

The network name is case sensitive. Press the number buttons repeatedly to change from lower to upper case characters. On the display of the Streamium System case-sensitive characters are distinguished by size. For example, "Gg" will be shown as "Gg."

- 2 Press ►OK to confirm.

→ Are you using an Access Point or Ad-Hoc network? appears.

- 3 Press the red button (SUBTITLE) on the remote control to select **Access Point**.

→ Are you using WEP encryption on your wireless network? appears.

- 4 If your network is not WEP encrypted, press the red button (SUBTITLE) on the remote control to connect to the Internet.

If the network is WEP encrypted, press the green button (ANGLE) on the remote control.

If the network is WEP encrypted

You will be asked to enter up to 4 encryption keys. Check the setup menu of your wireless router to see which encryption keys are used.

- 1 Use the number buttons to enter the encryption key. Next, press ►OK to confirm.
- 2 Repeat step 1 for all encryption keys. If not all of the 4 encryption keys are used in your network, enter "0" (zero) for no encryption key.

If the Streamium System does not connect to the Internet

The Streamium System may not connect to the Internet because

- a connection error has occurred. Press INTERNET again to reconnect.
- the wireless router is not connected to the Internet. Check if the computers in your network have access to the Internet.
- the IP settings are not correct. Continue with "If 'An IP address could not be obtained automatically. Would you like to enter your network settings manually?' appears."
- your Internet service provider is using a proxy. Continue with "If 'The system could not connect to the server.' appears."

If 'An IP address could not be obtained automatically. Would you like to enter your network settings manually?' appears

- 1 Press the red button (SUBTITLE) on the remote control to connect again to the Internet automatically. Always try this solution first. If necessary, repeat this step several times.
- 2 If the Streamium System connects to the Internet, continue with chapter "Registration."

If the Streamium System does not connect to the Internet, press the green button (ANGLE) on the remote control to enter the IP settings manually. Please contact your Internet service provider to get all the information you need below.

Next, you will be asked to enter

- the IP address for the Streamium System
- the netmask: Make sure all computers in your network as well as the Streamium System have the same netmask. If you are not sure, try 255.255.255.0.
- Default Gateway: the IP address of your router
- two DNS.

Use the number buttons on the remote control to enter each setting and press ►OK to confirm each setting.

If 'The system could not connect to the server.' appears

Maybe the system does not connect to the Internet because your Internet service provider uses a proxy. You need to enter the proxy name and proxy port. Please contact your Internet service provider to get this information.

- 1 Press the green button (ANGLE) on the remote control if your Internet service provider uses a proxy.
- 2 Use the number buttons to enter the proxy name. Next, press ►OK.
- 3 Use the number buttons to enter the proxy port. Next, press ►OK.
→ The Streamium System tries to connect to the Internet.

PC LINK connection

- After the Streamium System has connected successfully to the Internet, press PC LINK to connect to the PCs in your network.

The Streamium System may not connect to the PC because

- a connection error has occurred. Press PC LINK again.
- you have not yet installed the Philips Media Manager software on your PC.
- the PC is switched off.

B) PC with a wireless network card or with a wireless USB adapter

Follow these instructions

- if you have no router and
- if you have a PC with a wireless network card or with a wireless USB adapter.

You will be able to access media files (e.g. MP3 files) stored on your PC.

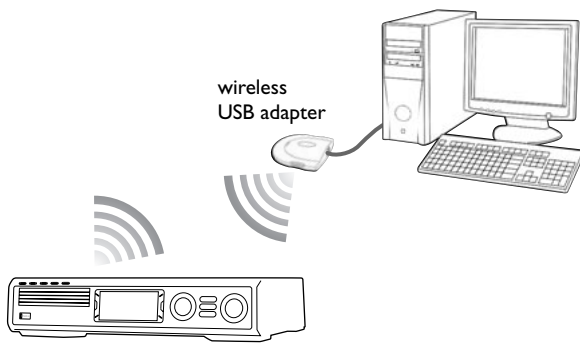

- 1 Make sure the network settings of the wireless network card on your PC are set to "ad-hoc mode" ("peer-to-peer" or "computer-to-computer").
- 2 If necessary, switch on your PC.
- 3 Press PC LINK on the remote control.
→ The Streamium System tries to connect automatically to a wireless network.
- 4 If the Streamium System connects to a wireless network, it will display its network name (SSID) briefly. **Please verify that the displayed network name corresponds to your PC.** If it does not, press SYSTEM MENU and select **Network Settings → Network Config.** to change the wireless network settings.

If the Streamium System connects to the PC, the computer name of your PC will be displayed. Please keep in mind that "network name" (SSID) and "computer name" are not the same.

If the Streamium System fails to connect, read the message on the TV screen and continue with one of the following paragraphs.

If 'Choose your wireless network' appears

Several wireless networks or one encrypted network are available.

- 1 Press ▼ or ▲ repeatedly to select the network name of your PC.

If the network name of your PC does not appear, press the red button (SUBTITLE) on the remote control to select **manual** and continue with "If 'Enter wireless network name (SSID)' appears."

- 2 Press the green button (ANGLE) on the remote control to confirm the selected network.

- 3 If the selected network is WEP encrypted, continue with "If the network is WEP encrypted."

If 'Are you using a wireless (WiFi/802.11) or a wired (Ethernet) network connection?' appears

- Press the red button (SUBTITLE) on the remote control to connect to a wireless network.

If 'Enter wireless network name (SSID)' appears

- 1 Press the red button (SUBTITLE) on the remote control to search again for all available networks or; use the number buttons to enter the network name (SSID) of your PC.

The network name is case sensitive. Press the number buttons repeatedly to change from lower to upper case characters. On the display of the Streamium System case-sensitive characters are distinguished by size. For example, "Gg" will be shown as "Gg."

- 2 Press ►OK to confirm.
→ **Are you using an Access Point or Ad-Hoc network?** appears.
- 3 Press the green button (ANGLE) on the remote control to select **Ad-Hoc network.**
→ **Are you using WEP encryption on your wireless network?** appears.
- 4 If your network is not WEP encrypted, press the red button (SUBTITLE) on the remote control to connect to your PC.

If the network is WEP encrypted, press the green button (ANGLE) on the remote control.

If the network is WEP encrypted

You will be asked to enter up to 4 encryption keys. For the encryption keys check the network settings of the wireless network card on your PC.

- 1 Use the number buttons to enter the encryption key. Next, press ►OK to confirm.
- 2 Repeat step 1 for all encryption keys. If not all of the 4 encryption keys are used in your network, enter "0" (zero) for no encryption key.

If the Streamium System does not connect to your PC

The Streamium System may not connect to the PC because

- a connection error has occurred. Press PC LINK again.
- you have not yet installed the Philips Media Manager software on your PC.
- the IP address of the Streamium System and that of your PC are not in the same subnet.
- the PC is switched off.

Internet and PC Link

C) Wired home network with a router

Follow these instructions if you have a home network with a router and broadband Internet access.

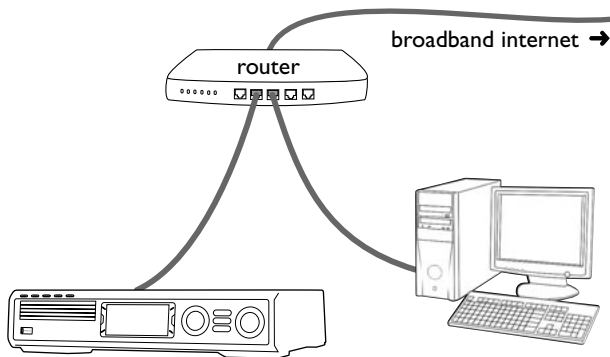

- 1 Connect ETHERNET on the Streamium System to a LAN port of your router with the supplied ethernet cable.
- 2 Press INTERNET on the remote control.

If the Streamium System connects to the Internet you will be asked to register with "My.Philips.com." Continue with chapter "Registration."

If the Streamium System does not connect to the Internet

The Streamium System may not connect to the Internet because

- a connection error has occurred. Press INTERNET again to reconnect.
- the router is not connected to the Internet. Check if the computers connected to the router have access to the Internet.
- the IP settings are not correct. Continue with "If 'An IP address could not be obtained automatically. Would you like to enter your network settings manually?' appears."
- your Internet service provider is using a proxy. Continue with "If 'The system could not connect to the server.' appears."

If 'An IP address could not be obtained automatically. Would you like to enter your network settings manually?' appears

- 1 Press the red button (SUBTITLE) on the remote control to connect again to the Internet automatically. Always try this solution first. If necessary, repeat this step several times.
- 2 If the Streamium System connects to the Internet, continue with chapter "Registration."

If the Streamium System does not connect to the Internet, press the green button (ANGLE) on the remote control to enter the IP settings manually. Please contact your Internet service provider to get all the information you need below.

Next, you will be asked to enter

- the IP address for the Streamium System
- the netmask: Make sure all computers in your network, as well as the Streamium System, have the same netmask. If you are not sure, try 255.255.255.0.
- Default Gateway: The IP address of your router
- two DNS.

Use the number buttons on the remote control to enter each setting and press ►OK to confirm each setting.

If 'The system could not connect to the server.' appears

Maybe the system does not connect to the Internet because your Internet service provider uses a proxy. You need to enter the proxy name and proxy port. Please contact your Internet service provider to get this information.

- 1 Press the green button (ANGLE) on the remote control if your Internet service provider uses a proxy.
- 2 Use the number buttons to enter the proxy name. Next, press ►OK.
- 3 Use the number buttons to enter the proxy port. Next, press ►OK.
→ The Streamium System tries to connect to the Internet.

PC LINK connection

- After the Streamium System has connected successfully to the Internet, press PC LINK to connect to the PCs in your network.

The Streamium System may not connect to the PC because

- a connection error has occurred. Press PC LINK again.
- you have not yet installed the Philips Media Manager software on your PC.
- the PC is switched off.

D) PC only with a network interface (Ethernet) card

Follow these instructions if you want to connect the Streamium System directly to your PC without using a wireless connection.

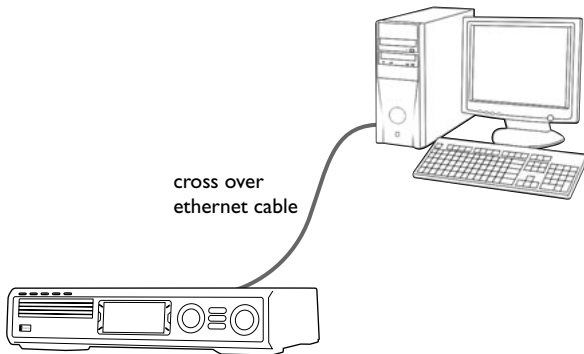

- 1 Connect ETHERNET on the Streamium System to the ethernet jack of the PC with a cross over ethernet cable (not supplied).

Only use a cross over ethernet cable to connect the Streamium System directly to the PC.

- 2 If necessary, switch on your PC.
- 3 Wait for 10 seconds, then press PC LINK on the remote control.
→ If the Streamium System connects to the PC, the computer name of your PC will be displayed.

If the Streamium System does not connect to the PC

The Streamium System may not connect to the PC because

- a connection error has occurred. Press PC LINK again.
- you have not yet installed the Philips Media Manager software on your PC.
- the PC is switched off.
- the IP address of the Streamium System and that of your PC are not in the same subnet.

Internet and PC Link

Registration

When the Streamium System connects to the Internet for the first time, you will be asked to enter your email address.

- 1 Use the number buttons on the remote control to enter your email address. If you mistyped, press ◀ to delete the character you have entered.
 - To exit without registering, press ■.
- Note: Internet services will be available only if you register.*
- 2 Next, press ►OK to send your email address.
→ Within a short time, you will receive an email with instructions on how to create your user's account at "My.Philips.com."
 - 3 Create the user's account at "My.Philips.com:"
 - 4 Next, press INTERNET on the the remote control to connect to the Internet.
→ The available media types (music, video, ...) appear:

About "My.Philips.com"

To activate online services, every owner of a Streamium System has to register with My.Philips.com. This website allows you to:

- select and manage online media services
- manage your Internet favorites
- add music streams (currently MP3, MP3pro) to the Streamium System that are not offered through the available Internet service providers
- find links to background information and online support
- download PC Link software
- purchase media

Prerequisites for My.Philips.com:

- a Streamium System
- a computer
- access to the Internet
- an Internet browser
- an email address

To access My.Philips.com, open your Internet browser and type in: <http://my.philips.com>

Reviewing and changing network settings

The Streamium System tries to connect automatically to your network. In case of any problems or after changing your network, you can change/review the settings of your network here.

- 1 If necessary, press INTERNET or PC LINK. Next, press SYSTEM MENU.
- 2 Press ▼ repeatedly to select **Network**. Next, press ►.
- 3 Press ▼ or ▲ repeatedly and select
 - **Network Type:** to switch between a wired and a wireless network,
 - **Network Config.:** to enter the network settings of your network (IP address, netmask, gateway and DNS),
 - **Wireless Config.:** to enter the settings of your wireless network (network name (SSID), channel number...)
 - **Encryption Config.:** to switch WEP encryption on/off and to enter the encryption keys
 - **Proxy Config.:** to enter the proxy name and proxy port
 - **Network Info.:** to review the network settings (IP address, netmask, ...),
 - **Wireless Info.:** to view information about the wireless network (network name, signal level, MAC address of the wireless card in your Streamium System, ...).
- 4 Next, press ► to enter the selected menu.

Internet services

The Internet is a rapidly evolving and changing medium. Available media services and media service providers may change with time. This manual gives a rough overview on how to select a media service. Please visit "My.Philips.com" for the latest list of services and service providers.

- 1 Press INTERNET on the remote control.
→ The available media types (music, video, ...) appear:
 - 2 Press ▲ or ▼ to select a media type. Next, press ►.
→ The available service providers for the selected media type appear:
 - 3 Press ▲ or ▼ to select a service provider. Next, press ►.
→ The following menus will depend on the service provider:
For example, you may select among different categories of music or video clips.
 - 4 Press ► to enter a category. Press ▲ or ▼ to select a service (e. g. an Internet radio station ...). Next, press ►OK to start the selected service.
- To go back to the previous menu, press ◀.

PC LINK

With PC LINK you get access to the media files (music, pictures, video) stored on the PCs of your home network and play them on your Streamium System. Select the media files directly on the Streamium System.

For the latest information on the supported media formats please visit "My.Philips.com."

To use PC LINK

- your PC must be switched on.
- the Philips Media Manager software must be installed on the PCs of your home network. Please refer to the installation guide of the Media Manager software for installing the software and making media files of your PCs available to the Streamium System.

- 1 Press PC LINK to connect to the PCs of the network.
→ The PCs of your home network on which you installed the Philips Media Manager software appear:

Notes:

If No PCs found appears, the Streamium System has not been able to connect to the PCs. Repeat step 1 until the unit connects properly or check your network settings.

If you do not use a router, only one PC will be available.

- 2 Press ▼ or ▲ repeatedly to select a PC. Next, press ►.
→ The available media types (music, pictures, video) on the computer appear:
- 3 Press ▼ or ▲ repeatedly to select a media type.
Next press ►.
→ The available media files appear:
- 4 Press ▼ or ▲ repeatedly to select a file, then press ►OK to play it.

Internet and PC Link

Using the colored multifunction buttons – SUBTITLE, ANGLE, ZOOM and AUDIO

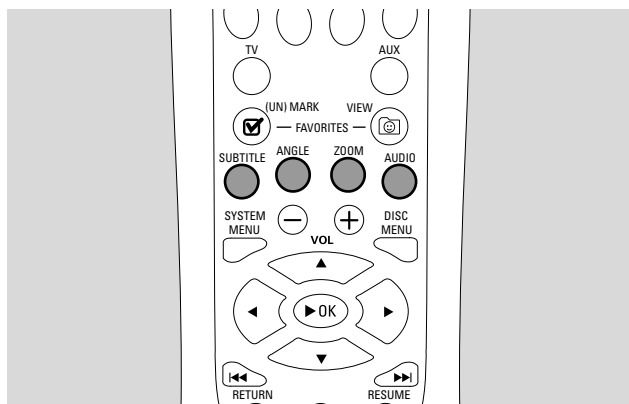

The function of the colored buttons on the remote control (SUBTITLE, ANGLE, ZOOM and AUDIO) and of the 2 multifunction buttons on the Streamium System depend on the media type you are using. The display on the TV screen will indicate which buttons have a special functionality.

INFO!

Some Internet media service providers offer additional information about the media that is currently playing, e. g. the track/artist played on the selected Internet radio station. The availability of INFO! depends on the media and the media service provider.

- Press INFO! to receive an email from My.Philips.com with information about the media currently played.

Notes:

The requested information is also available at your My.Philips.com account.

If no information is available, NO INFO AVAILABLE appears.

FAVORITES

To handle the large amount of Internet services easily, you can add Internet services to your favorites. The favorites feature is available for INTERNET services only.

Adding a service to your favorites

- 1 Select an Internet service (Internet radio station, movie ...).
 - indicates that the service is already a favorite.
 - indicates that the service is not a favorite yet.
 - 2 Press (UN)MARK FAVORITES to add the service to your favorites.
- To remove a favorite Internet service from your favorites, select the service and press (UN)MARK FAVORITES twice within 2 seconds.

Note: There may be some media services that you cannot add to your favorites.

Accessing your favorites

- 1 If necessary, press INTERNET.
 - 2 Press VIEW FAVORITES to view your favorites.
- To view the favorites of one media type only (e. g. music), press the red multifunction button (SUBTITLE). Press ▲ or ▼ repeatedly to select the media type. Next, press ►OK to confirm.
- 3 Select any favorite and press ►OK to play it.

Recently used media services – RECENT

RECENT lets you review and quickly access the media services you have been using recently. RECENT displays the last 20 media services you have been using. RECENT is available for INTERNET only.

- 1 Press RECENT to display the media services you have used recently.
- 2 Press ▼ or ▲ repeatedly to select a media service.
- 3 Press ►OK to start the media service.
- To switch RECENT off and return to the normal display, press RECENT again.

Multiple users – USER

You can "personalize" this Streamium System for various users. Each user will have his own user account at My.Philips.com, his own favorites, and get information to his email address when pressing INFO!

Adding a new user

- 1 Press USER to display the users of this Streamium System.
- 2 Press the green multifunction button (ANGLE) on the remote control to add a new user.
- 3 Use the number buttons to enter the email address of the new user.
- 4 Press ►OK to confirm.

5 **If you entered the email address of a user already registered with "My.Philips.com":**

Use the number buttons to enter the user's password. Next, press OK.

If you entered the email address of a user who has not registered yet:

An email will be sent to the new user with further instructions on how to register. The user will be available on this Streamium System shortly after registration.

Selecting a user

- 1 Press USER to display the users of this Streamium System.
- 2 Press ▲ or ▼ repeatedly to select a user.
- 3 Press ►OK to confirm.
→ The nickname of the selected user appears.

Removing a user

- 1 Press ▲ or ▼ repeatedly to select the user you want to remove from the unit.
- 2 Press the red multifunction button (SUBTITLE) on the remote control to remove the user.
- 3 Enter the password of the primary user, i. e. the user who was the first to register this unit.
- 4 Press ►OK to confirm.
→ The user will be removed from the unit.

Notes:

You cannot remove the primary user on the unit. But you can delete the account of the primary user at "My.Philips.com" or change its personal data at any time.

Some features (e .g . Parental level) are only available to the primary user of the unit.

General Information

When referring to this manual, remember ...

[DVD] Indicates the feature may be on some Digital Video Discs.

[CD] Indicates the feature may be on some Audio Compact Discs.

[VCD] Indicates the feature may be on some Video Compact Discs.

[MP3] Indicates the feature may be on some MP3 Discs.

Playable Discs

This system will play Digital Video Discs (DVDs), (Super) Video CDs, and Audio CDs. This system will also play MP3 files (music tracks compressed with MPEG 1 Audio Layer 3 technology) recorded onto a Compact Disc Recordable (CD-R) or a Compact Disc Rewritable (CD-RW).

Discs having the following logos should play on this Streamium System.



This Streamium System supports only the first session of multi-session discs.

Important!

1) This system is designed for regular discs. Therefore, do not use any accessories such as disc stabilizer rings or disc treatment sheets, etc. as offered on the market, because they may cause jamming of the changer mechanism.

2) Do not load more than one disc into one disc tray.

Region Codes

DVDs must be labelled for **ALL regions** or for **Region 1** in order to play on this system. You cannot play discs that are labelled for other regions.



The number inside the globe refers to a region of the world. A disc encoded in a specific region format can play only on DVD Players that have the same region code. So, if a disc is labelled for Region 2, you cannot play that DVD on this Streamium System (because it is a Region 1 system).

Available disc Features

Features described in this manual may not be available on every disc. If the feature is not on the disc, you cannot use the system to make the feature available. An "X" will appear in the top left corner of the TV screen if you try to access a feature that is not on the disc.

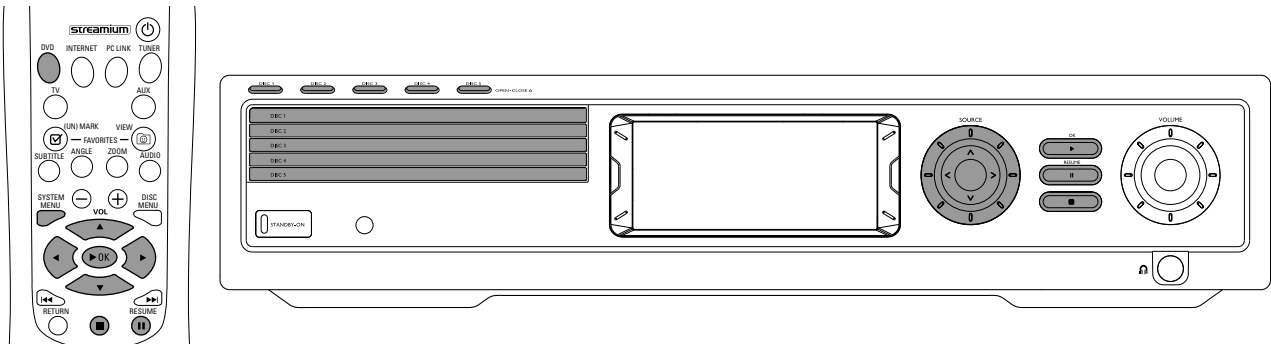

Disc Playback [DVD/VCD/CD]

- 1 Press DVD on the remote control to turn on the system.
- 2 Turn on your TV. Set it to the correct Video In channel.
→ You should see the Streamium System's blue background screen on the TV.
- 3 Press DISC 1 (OPEN/CLOSE ▲) on the Streamium System to open disc tray 1. Load your disc in the tray, with the label facing up and the shiny side facing down. If the disc is two-sided, ensure that the side you wish to play is facing up.
- 4 Press DISC 1 (OPEN/CLOSE ▲) again to close the tray.
 - To load the rest of the disc trays, press the respective DISC (OPEN/CLOSE ▲) button. Then press the same button again to close the disc tray.
- 5 Press DVD on the remote control repeatedly or rotate SOURCE on the Streamium System to select the disc that you want to play.
- 6 If playback does not start automatically, press ►OK.
 - If DVD playback does not start automatically, a disc menu may appear. If the title or chapter selections are numbered, press a Number button on the remote control to select an item. Or press ◀, ▶, ▲, ▼ to select an item for playing, then press ►OK.
 - Press || to pause playback temporarily. To resume playback, press ►OK.
- 7 Press ■ to stop playback.

Note: You can only open one disc tray at a time. If the current disc tray is open and you attempt to open another disc tray, the first disc tray will close automatically before the second disc tray can be opened.

Selecting next disc

- Press DVD on the remote control or rotate SOURCE on the Streamium System to select the next disc you wish to play.

Resume [DVD/VCD]

The resume feature is available with the last five DVDs and (Super) Video CDs you played.

- 1 Press ■ on the remote control to stop playback.
 - Resume feature is activated.
 - The next time you start playing the same disc, play will resume at the same point at which you last stopped it.
- However, if you press ■ twice to stop disc playback, resume will not be activated. The next time you start playing the same disc, play will start at the beginning of the disc.
- If the resume symbol appears on the TV screen when you reload a disc, play will resume from the point at which you last stopped playback if you press ► while the resume symbol is still displayed.

Note: Resume may not be available with some discs.

Chapter Preview [DVD]

This feature allows you to preview the first 10 seconds of each DVD chapter.

- 1 Press SYSTEM MENU. Next, select **Toolbar → View → Chapter Preview**.
- 2 Press ► to select **On**. Next, press SYSTEM MENU to exit the system menu.
 - The first 10 seconds of every chapter will be shown. After that, playback will stop.
- To switch **Chapter Preview** off and continue with normal playback, press ►OK.

Chapter/track selection

[DVD/VCD/CD]

- 1 Press ►► briefly during playback to go to the next track/chapter.
Press ◀◀ briefly to return to the beginning of the current track/chapter.
Press ◀◀ repeatedly and quickly to step back to previous tracks/chapters.
- 2 To go directly to any track/chapter during playback, press the number buttons to enter the track/chapter number:
→ The System Menu Bar may appear briefly. It will disappear once the new track/chapter starts to play.

Make sure the track/chapter number you enter is available on the disc. When you enter an invalid number
→ an "X" may appear in the top left corner of the TV screen.
→ the current track or Chapter will continue to play.
→ an incorrect track/chapter may begin to play.

Forward and Reverse Searching

[DVD/VCD/CD/MP3]

You can do a forward or reverse searching while playing back a DVD, VCD, CD or MP3 disc.

- 1 On a DVD or (Super) Video CD, to search the disc at four times the normal speed, press and hold ◀◀ or ►► for about two seconds during playback. To search at 32 times the normal speed, press and hold ◀◀ or ►► again (DVD only).
→ The sound will be muted.
On an Audio CD, to search the disc at four times the normal speed, press and hold ◀◀ or ►► for about two seconds during playback. Sound will be intermittent. To search at eight times the normal speed, press and hold ◀◀ or ►► again.
→ The sound will be muted.
- 2 To end the search, press ►OK to resume playback or press ■ to stop playback.

Note: This feature is available in the System Menu as **Fast**.

Searching in the System Menu

In the system menu, additional search features are available: Time Search, Fast Motion, Slow Motion.

- 1 Press SYSTEM MENU.
- 2 Select **Toolbar** → **Search**.
Time Search [DVD/VCD]
Time Search lets you choose a specific elapsed playing time at which you want to begin disc playback.
- 1 Select **Time**.
→ Playback will pause.
→ A time edit box will appear, showing the elapsed playing time of the current disc, or the point at which the disc is currently.

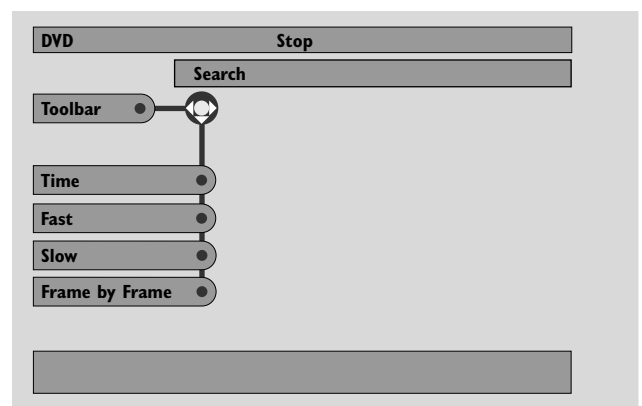

- 2 Press the number buttons to enter the time at which you want playback to begin. Enter the hour, minute, and second from left to right in the box.
→ Make sure the time you enter is within the total playing time of the current Title/track.
- 3 Press ►OK.
→ Playback will start at the point you have selected after a few seconds.
- If you enter an invalid time, the incorrect information will blink in the time edit box. Enter a time that is available in the current Title/track and press ►OK again.

Fast, Slow [DVD/VCD]

- 1 Select the speed:
Fast: -32x, -8x, -4x (backward), or 1x, 4x, 8x, 32x (forward).
 -32x, 32x ... DVD only.
Slow: -1, -1/2, -1/4 or -1/8 (backward), or 1/8, 1/4, 1/2 or 1 (forward).
 → Sound will be muted during Fast (Slow) Motion playback.
- Press **II** on the remote control to pause the picture.
- 2 To return to normal playback, press **▶OK**.

Notes:

Start forward **Fast** Motion playback simply by pressing **▶** during playback. Press **▶** repeatedly to choose a **Fast** Motion speed.

If you reach the beginning of the disc or title during a reverse search, regular playback will resume automatically.

Still Picture/Frame-by-Frame Playback [DVD/VCD]

This feature allows you to view individual frames as still pictures during playback.

- 1 During playback, press **II** on the remote control.
 → A still picture will appear on the TV screen.
- 2 To advance the still picture one frame at a time, press **II** repeatedly.
- 3 To resume normal playback, press **▶OK**.

Notes:

You can also pause the picture by pressing **▲** during playback.

Frame-by-Frame playback is also available in the System Menu.

Repeat [DVD/VCD/CD]

You may play a chapter, track, title, or entire disc repeatedly.

- 1 During playback, press REPEAT on the remote control repeatedly to choose a repeat mode.
 - To repeat the current chapter/track, press REPEAT once.
 → REPEAT CHPT or REPEAT TRK will appear on the display of the Streamium System.
 - To repeat the current title, press REPEAT repeatedly until REPEAT TITL appears on the display of the Streamium System.
 - To repeat the entire disc, press REPEAT repeatedly until REPEAT DISC appears on the display of the Streamium System.
- 2 To cancel repeat playback, press REPEAT repeatedly until REPEAT OFF appears on the display of the Streamium System.

Notes:

Repeat can only be used for the selected disc tray.

Repeating more than one disc tray is not possible.

Shuffle [DVD/VCD/CD]

On a DVD, this shuffles the playing order of chapters within a title, if the title includes more than one chapter. On an Audio CD and (Super) Video CD, activating Shuffle will play all the tracks in random order.

- 1 Press SHUFFLE on the remote control.
 → SHUFFLE will appear briefly on the display of the Streamium System. The tracks or chapters will begin playing in random order.
- 2 To return to normal order playback, press SHUFFLE again.
 → Regular playback will resume from the current track/chapter.
 → SHUFFLE OFF will appear briefly on the display of the Streamium System.

Notes:

Shuffle can only be used for the selected disc tray.

Shuffling more than one disc tray is not possible.

Program [DVD,VCD, CD, MP3]

Program allows you to play your favorite titles/chapters or tracks/indexes in the order you select.

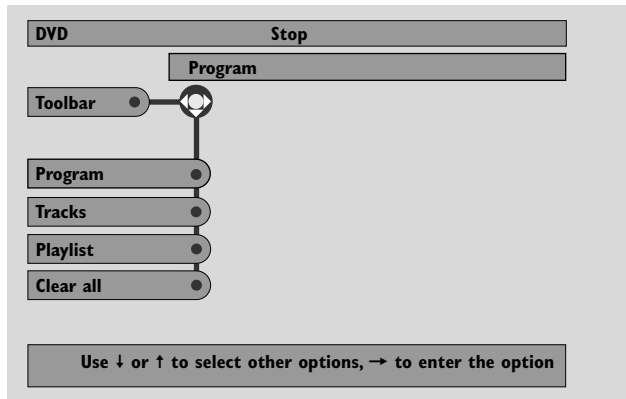

1 Press SYSTEM MENU.

2 Select **Toolbar** → **Program**.

Programming tracks/chapters/titles

1 To program your favorite tracks, chapters, or titles, press ▼ repeatedly to select **Tracks**. Next, press ►.

2 Press ▲ or ▼ to select the desired track, chapter, or title, then press ►OK.
→ The selected track, chapter, or title will be stored.

○ To store other tracks, chapters or titles, repeat step 2.

3 Press ◀ to exit the menu.

Playing a program

1 Press ▲ to select **Program**.

2 Press ► repeatedly to select **On**. Next, press ►OK.
→ **FTS on** (Favorite track selection) appears.
Your program will play.

○ To return to normal playback, select **Toolbar** → **Program** → **Program**. Press ► repeatedly to select **off**. Next, press ►OK.
→ **FTS off** appears.

Reviewing / Deleting programmed tracks

Playlist allows you to view the tracks, chapters or titles of your program.

1 Press ▼ repeatedly to select **Playlist**. Next, press ►.

2 Press ▲ or ▼ repeatedly to scroll through the tracks, chapters, or titles of your program.

○ To delete a track, chapter or title from your program, press ▲ or ▼ repeatedly to select the track, then press ►OK.
→ The selected track, chapter or title will be deleted from your program.

3 Press ◀ to exit the menu.

Note: Playlists generated on a computer and stored on the CD-ROM are not supported.

Clearing the entire program

1 Press ▼ repeatedly to select **Clear all**.

2 Press ► to clear the entire program.
→ **Cleared** will be displayed and the program will be cleared.

Disc Menu [DVD]

- 1 Press DISC MENU on the remote control.
 - If the current title of the current disc has a menu, the title menu will appear on the screen.
 - Otherwise, the main DVD disc menu will appear. The menu may list camera angles, spoken language and subtitle options, chapters for the title, or other disc features.
- 2 Press ◀▶▲▼ on the remote control to select the desired items in the menu, then press ▶OK.
- 3 If you do not start playback from the menu, press DISC MENU to exit.

Audio [DVD,VCD]

Some DVDs are recorded in different languages. You may be able to hear the same movie dialog in English, French, Spanish, etc.

- 1 Press AUDIO on the remote control during DVD playback.
- 2 Press AUDIO repeatedly within five seconds to see the different languages available. Or press ▲ or ▼ to see the different languages.
 - The language you select will be audible in a few seconds.
- 3 Press ▶OK to exit.

Note: Audio is also available in the System Menu.

Subtitles [DVD]

Some DVDs include subtitles in different languages.

You can choose subtitles only if they are available on the DVD.

- 1 Press SUBTITLE on the remote control during DVD playback.
- 2 Press SUBTITLE repeatedly within five seconds to see the different subtitle languages. Or press ▲ or ▼ to see the different subtitle languages.
 - The language may be abbreviated or numbered.
 - Subtitles will appear after a few seconds.
- 3 Press ▶OK to exit.

Note: Subtitle is also available in the System Menu.

Camera Angle [DVD]

Some DVDs include scenes recorded from different angles. You can watch these different angles if the angle symbol  ANGLE appears during DVD playback. If the DVD was not recorded with different angles, this feature is not available. Check the DVD case first to see if multiple angles are available.

- 1 During DVD playback,  ANGLE will appear at the top of the TV screen if multiple angles are available.
- 2 Press ANGLE on the remote control during DVD playback.
 - The available angles will appear.
- 3 Press ANGLE or ▼ or ▲ repeatedly to select the angle from which you want to watch the current scene.
- 4 Press ▶OK to exit.

Note: Angle is also available in the System Menu.

Zoom [DVD]

This feature lets you enlarge the video image during playback and pan through the enlarged image.

- 1 Press ZOOM on the remote control during playback.
 - Four arrows and a yellow dot appear on the TV screen.

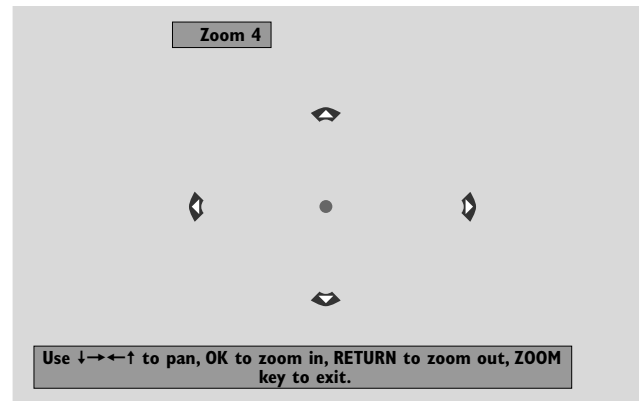

- 2 While the arrows and the yellow dot are displayed: Press ▶OK repeatedly to select the zoom factor: **Zoom 1, Zoom 2, Zoom 4, Zoom 8**. Press ◀▶▲▼ to move to the left, right, top, or bottom of the picture.
- 3 Press ZOOM to exit.
- To return to normal playback, press ZOOM. Next, press ▶OK repeatedly to select **Zoom 1**. Press ZOOM again.

Note: Zoom is also available in the System Menu.

Selecting the menu language, country, audio language and subtitle language

These features are only available when DVD is selected.

- 1 Press SYSTEM MENU on the remote control.
- 2 DVD: Select **Setup → Language**.

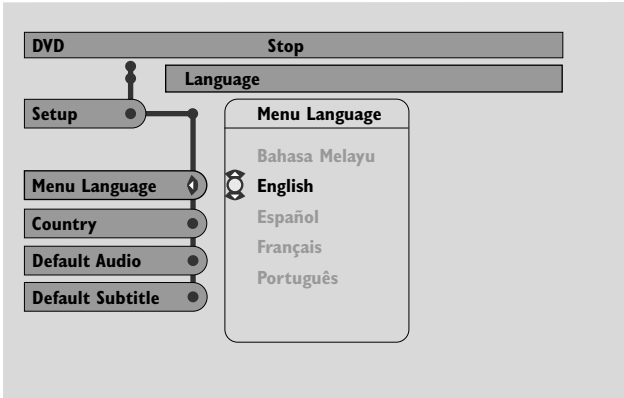

Menu Language [DVD,VCD, CD, MP3]

Select your preferred language for the System menu.

- Press ▲ or ▼ to select the desired language, then press ►OK to confirm.

Country [DVD,VCD, CD, MP3]

Select the country where this Streamium System is used.

- Press ▲ or ▼ to select the country, then press ►OK to confirm.

Default Audio (DVD)

Select the audio language you prefer whenever you play any DVD. If the default language is not available on the DVD, the first audio language on the disc will be selected.

- Press ▲ or ▼ to select the desired default audio language, then press ►OK.

Default Subtitle (DVD)

Select the subtitle language you prefer whenever you play any DVD. If the default subtitle is not available on the DVD, the first subtitle on the disc will be selected.

- Press ▲ or ▼ to select the desired default subtitle language, then press ►OK.

Playback Control (PBC) [VCD]

This feature is available only for (Super) Video CDs compatible with PBC. (Super) Video CDs with Playback Control offer additional features. Check the (Super) Video CD case for details.

Switching PBC on/off [VCD]

- 1 Press SYSTEM MENU on the remote control.
- 2 Select **Setup → Features → PBC**.
- 3 Press ► repeatedly to switch PBC on or off. Next, press ►OK.

Note: If a (Super) Video CD does not play, set PBC to Off.

Playing a (Super) Video CD with PBC

- 1 Load a (Super) Video CD with PBC and press ►OK.
→ The (Super) Video CD will show instructions or options on the TV screen.
- 2 Use the remote control buttons as directed by the (Super) Video CD.
 - To return to a previous menu, press RETURN.
 - If a PBC menu has titles, select a title directly by pressing the number buttons on the remote control.

Playing MP3 discs

MP3 is a compression method that makes digital music files up to 10 times smaller without losing significant sound quality. MP3 is common on the Internet, letting you transfer tracks to your computer and onto a CD Recordable or CD Rewritable.

MP3 files are recorded at a certain bit rate or speed. For a good sound quality a bit rate of 128 kbps or higher is recommended.

This system supports the following formats:

- File names ending in .mp3
- Names of albums, artists, etc., with a maximum of 30 characters
- Maximum nested directory of eight levels
- Sampling frequencies: 32 kHz, 44.1 kHz, 48 kHz
- Bit-rates: 32-320 kbps
- Multisession discs, if finalized

The following formats are not supported:

- File names ending in .wma, .aac, .dlf, .m3u, and .pls
- Chinese file names
- unfinalized discs
- discs recorded in UDF format

- 1 Insert a disc with MP3 files.
 - It may take the Streamium System several seconds to recognize the MP3 disc. MP3 text may appear on the TV screen or the display of the Streamium System. This could be the song title, artist name, track number, etc., depending on how you recorded the MP3 files.

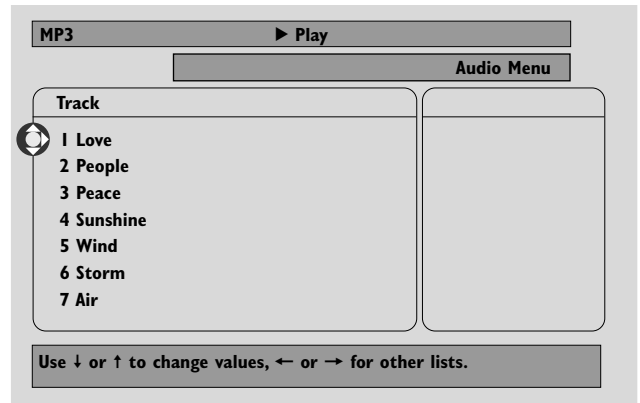

- 2 Press ▲ or ▼ or use the number buttons to select an album.
- 3 If you want to play the selected album, press ►OK.
 - If you want to play a track of the album, press ► to enter the selected album. Press ▼ or ▲ repeatedly or use the number buttons to select a track. Next, press ►OK to play the selected track.
 - To skip to another track, press ▲ or ▼ or use the number buttons.
 - To search within an MP3 track, press |◀◀ or ▶▶|.
 - To select an available repeat option, press REPEAT repeatedly.

Playing picture CDs

With the Streamium System you can play Kodak Picture CDs and your own CD-R(W)s with JPEG pictures (.jpg, jpeg).

- 1 Insert a disc with JPEG pictures.
 - It may take the Streamium System several seconds to find the pictures.
 - A preview of 4 pictures will be displayed.
- To see the next 4 pictures, press ►►|. For the previous 4 pictures, press |◄◄.
- 2 Press ◀, ▶, ▲ or ▼ to select a picture.
- 3 Press ►OK to display the picture.
 - The selected picture will be displayed.
- To skip to the previous or next picture, press |◄◄ or ►►|.

Note: Some pictures may appear distorted.

Rotating a picture

You can rotate a picture in 90 degree steps. Rotate only affects the selected picture.

- 1 Select a picture and press ►OK to display the picture.
- 2 Press SYSTEM MENU.
- 3 Select **Toolbar → View → Rotate**.
- 4 Press ► to enter the menu. Next, press ◀ or ▶ to select the rotation angle.
- 5 Press ►OK to confirm.
 - The current picture will rotate.
- 6 Press SYSTEM MENU to exit the menu.

Playing a slide show

Play all the pictures of the inserted disc in sequence.

- 1 Select a picture and press ►OK to display the picture.
- 2 Press ►OK again to display all pictures of the inserted disc in sequence.
- To adjust the time each picture will appear on the TV screen, press SYSTEM MENU on the remote control and select **Toolbar → Slideshow → Picture Time**. Select Slow, Medium, or Fast. Next, press SYSTEM MENU to exit the menu.
- 3 To stop the slide show, press ■.

Access Control [DVD]

Some DVDs may not be suited for children. With Access Control you can limit the scenes to be shown. This feature will not work if the disc is not provided with access control information. Philips cannot guarantee the availability of Access Control with all discs, and therefore denies any liability associated with unintended viewing of discs. Make sure your discs play according to your Access Control settings before you allow children to access to the Streamium System.

- 1 Press SYSTEM MENU on the remote control.
- 2 DVD: Select **Setup** → **Access**.

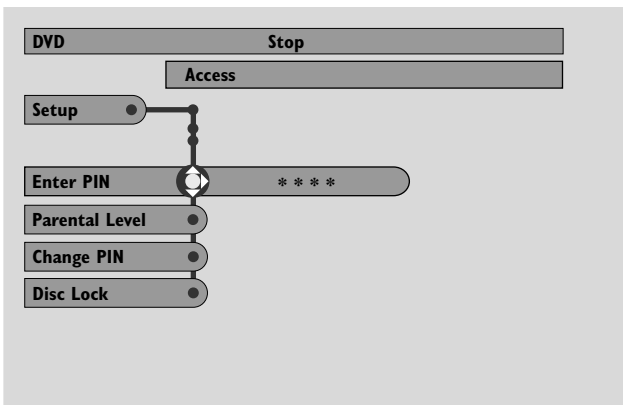

- 3 Press ▼ to select **Enter PIN**. Next, press ►.
- 4 Use the number buttons to enter the four digit code. When using the Streamium System for the first time, enter "0000."
- To exit the menu without entering the PIN code, press SYSTEM MENU.
- 5 Press ▼ repeatedly to select either **Parental Level**, **Change PIN** or **Disc Lock**. Press ► to enter the selected menu.

Parental Level

DVDs may contain alternative scenes that conform to the Parental Level, or movie rating, that you select. The Parental Level may apply to the complete disc or to certain scenes on the disc. Follow the steps below to set the Parental Level at which you want the discs to play.

- Press ▲ or ▼ or the number buttons (0-8) to select a rating, then press ►OK.
- Select "0" (—) to deactivate Parental level. Or choose a rating between 1-8; discs or scenes with the same rating or lower will play. Higher rated discs or scenes will not play unless you enter your four digit code. Follow the directions given by the disc to enter your code and start playback.

Note: The rating numbers compare to standard U.S. movie ratings as follows: 7 for NC-17; 6 for R; 4 for PG-13; 3 for PG, and 1 for G.

Change PIN

- 1 Use the number buttons to enter the current Pin.
→ **Enter New Pin** appears.
- 2 Use the number buttons to enter the new Pin.
→ **Confirm Pin** appears.
- 3 Enter the new Pin again to confirm it.
→ The Pin code is changed.

Note: Sometimes, the system will ask you to enter your code twice to confirm the code. This is normal.

Disc Lock

Use Disc Lock to disable viewing of a specific disc, regardless of its rating. A DVD must be in the disc tray.

- 1 Press ► repeatedly to select
→ **On**: Disc Lock is switched on. Locked discs will not play unless you enter your four digit code.
→ **Off**: Disc Lock is switched off.
- 2 Next, press ►OK.

Note: Lock/unlock each side of two sided DVDs and each volume of multi-volume (Super) Video CDs.

If you forget your Pin

- 1 When asked to enter the PIN code, press ■.
- 2 Press DVD repeatedly to select a disc tray with no disc.
- 3 Press SYSTEM MENU.
- 4 Select **Setup** → **Access** → **Enter PIN**. Next, press ►.
- 5 Press ■ 4 times.
→ **Not possible now** appears.
→ **Enter New Pin** appears.
- 6 Use the number buttons to enter the new Pin code.
→ **Confirm Pin** appears.
- 7 Enter the new Pin code again to confirm it.
→ The Pin code is changed.

System Menu – Picture settings

Adjusting the Picture Settings

This submenu allows you to adjust the settings for color, brightness, contrast, sharpness, saturation and video shift. These features are only available when DVD is selected.

- 1 Press SYSTEM MENU on the remote control.
- 2 DVD: Select **Preferences** → **Picture**.

Color Settings

You can select predefined color settings or make your own personal color settings. Although similar to adjusting Brightness, Contrast, etc. on your TV, these settings affect the picture the Streamium System sends to the TV.

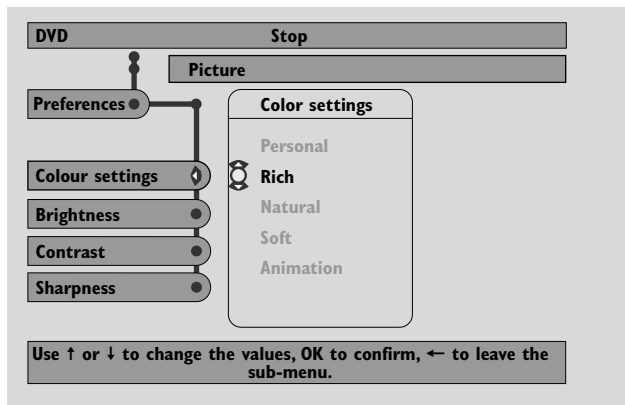

- Press ▲ or ▼ to select **Rich, Natural, Soft, Animation** or **Personal**, then press ►OK.

You may want to play a disc for a few minutes in each setting to decide which you prefer.

If you selected **Personal**, adjust the brightness, contrast, sharpness and saturation settings manually.

Brightness

- Press ◀ or ▶ to adjust to the desired picture brightness, then press ►OK.

Contrast

- Press ◀ or ▶ to adjust to the desired picture contrast, then press ►OK.

Sharpness

- Press ◀ or ▶ to adjust to the desired picture sharpness, then press ►OK.

Saturation

- Press ◀ or ▶ to adjust the color saturation, then press ►OK.

Video Shift

Use this feature to center the picture horizontally on the TV screen, or "shift the video" from left to right.

- Press ◀ or ▶ to center the picture on your TV screen, then press ►OK.

Night Mode

Night mode reduces the volume differences between loud and quiet passages. At night, you can enjoy surround effects at low volume without disturbing your children or neighbors. Night mode is available only for Dolby Digital and MPEG multi-channel signals and only if supported by the source material (e. g. a movie).

- 1 Press SYSTEM MENU on the remote control.
- 2 DVD: Select **Preferences → Sound → Night Mode**.
INTERNET, PC LINK: Select **Audio → Night Mode**.

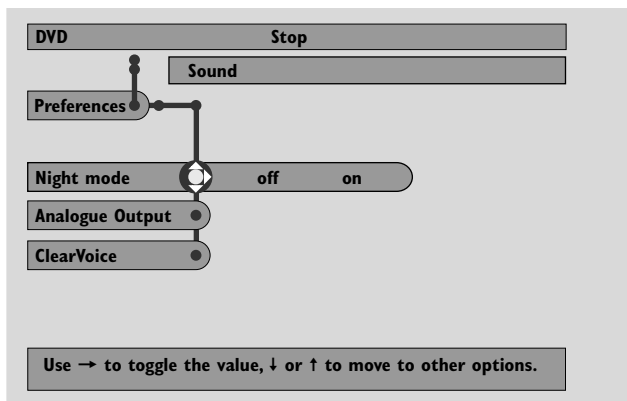

- 3 Press **▶** repeatedly to switch Night Mode on or off. Next, press **▶OK** to confirm.

Analogue Output

This feature is similar to selecting the surround sound with SURROUND on the remote control.

- 1 Press SYSTEM MENU on the remote control.
- 2 DVD: Select **Preferences → Sound → Analogue Output**.
INTERNET, PC LINK: Select **Audio → Analogue Output**.
- 3 Press **▼** repeatedly to select **Multi-channel, Hall** or **Stereo**. Next, press **▶OK** to confirm.

*Note: If you connected any equipment (e. g. a tape deck) to LINE OUT on the Streamium System and the equipment is suited for stereo signals only, set **Analogue output** to **Stereo**.*

Digital Output

Adjust Digital Output if you have connected the Streamium System's DIGITAL OUT to external digital equipment.

- 1 Press SYSTEM MENU on the remote control.
- 2 DVD: Select **Setup → Audio Menu → Digital Output**.
INTERNET, PC LINK: Select **Audio → Digital Output**.
- 3 Press **▲** or **▼** to select
 - **Off** if you do not use DIGITAL OUT in your connections.
 - **PCM only** if you use DIGITAL OUT in your connections, but the Stereo equipment does not include a built-in digital multi-channel decoder.
 - **All** if you have connected the Streamium System to Stereo equipment that has a built-in multi-channel decoder.
- 4 Next, press **▶OK** to confirm.

System Menu – Audio settings

Speaker layout, speaker distances and volume balance

For optimal multi-channel sound experience, the Streamium System can take the arrangement of your speakers and your listening position into account. Select from different speaker layouts or set the speaker distances and the volume balance between the speakers individually.

When DVD is selected, the speaker layout is not available. But if you select a speaker layout when INTERNET, PC LINK or AUX is selected, this setting will also be valid for DVD.

Speaker layout

- 1 Press AUX (or INTERNET or PC LINK) on the remote control.
- 2 Press SYSTEM MENU on the remote control.
- 3 Select **Audio → Speaker Layout**. Next, press ► to enter the menu.

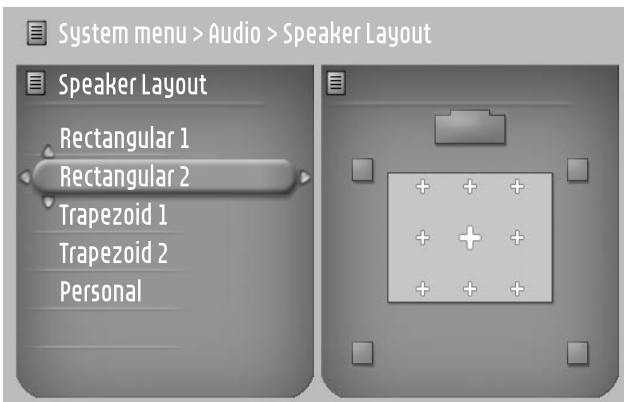

- 4 Press ▼ or ▲ to select the speaker layout which resembles the speaker arrangement in your home (**Rectangular 1**, **Rectangular 2**, **Trapezoid 1**, **Trapezoid 2**) or select **Personal** to adjust the speaker distances and the volume balance individually.
- 5 Press ► to enter the selected speaker layout. Next, use ◀, ▶, ▲, ▼ to select your listening position in the layout.
- 6 Press ►OK to confirm.
- 7 Press SYSTEM MENU to exit the system menu.

Speaker distances and volume balance

Instead of selecting a speaker layout, you can set the distances between the speakers and your listening position and the volume balance between the speakers.

To perform these settings, press SYSTEM MENU on the remote control and select

DVD: **Setup → Speakers**,

INTERNET, PC LINK: **Audio → Speaker Layout → Personal**.

System Menu – Additional features

Help Line and Status window

These features are only available when DVD is selected.

- 1 Press SYSTEM MENU.
- 2 DVD: Select **Preferences** → **Features**.

Help Line

Set **Help Line** to **On** if you want to see helpful information in the System Menu. When you select an item in the System Menu, an explanation will appear at the bottom of the TV screen.

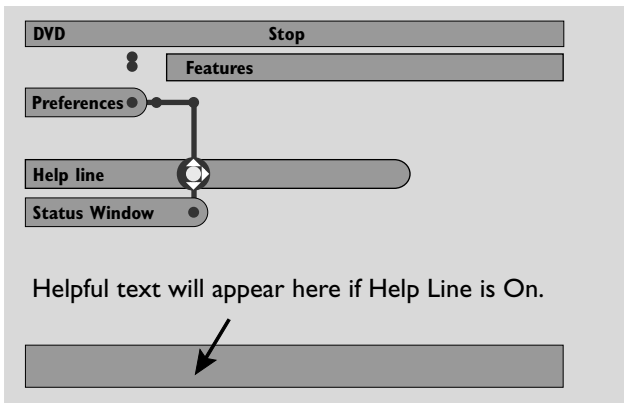

- Press ► repeatedly to switch Help Line on or off, then press ►OK to confirm.

Status window

The Status window may indicate when the disc tray is opening or closing, what type of disc is loaded, and total or remaining disc playback time.

- Press ► repeatedly to switch Status window on or off, then press ►OK to confirm.

Sleep timer

The sleep timer (Smart Power Off) enables the Streamium System to switch automatically to standby 20 minutes after a disc or an online service has stopped playing if no other activities have been performed.

When INTERNET or PC LINK is selected, the "Sleep timer" feature is called "Smart Power Off."

- 1 Press SYSTEM MENU on the remote control.
- 2 DVD: Select **Setup** → **Features** → **Sleep timer**. INTERNET, PC LINK: Select **Preferences** → **Smart Power Off**.
- 3 Press ► repeatedly to switch the sleep timer on or off. Next, press ►OK to confirm.

Adjusting the display brightness

- 1 Press SYSTEM MENU on the remote control.
- 2 INTERNET, PC LINK: Select **Preferences** → **Dim Level**.
- 3 Press ◀ or ▶ to select one of the levels for the display brightness.
- 4 Next, press ►OK to confirm.

Online upgrade

The system checks if the latest software is installed on your Streamium System. For this feature, you need broadband Internet access. This feature is only available when INTERNET or PC LINK is selected.

- 1 Press SYSTEM MENU on the remote control.
- 2 INTERNET, PC LINK: Select **Online Upgrade**.

Resetting the Streamium System

When resetting the Streamium System, you will lose all your settings (network settings, TV settings, etc.). After resetting do not forget to perform the TV settings of chapter "Settings for the TV."

- 1 Press SYSTEM MENU.
- 2 INTERNET, PC LINK: Select **Reset settings**. Next, press ►.
→ **Do you want to delete all settings** appears.
- 3 Press the red button (SUBTITLE) to confirm.

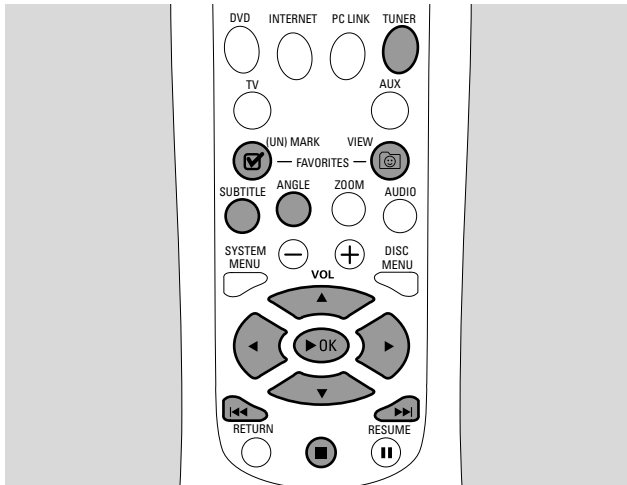

Tuning to radio stations

- 1 Press TUNER on the remote control to select TUNER.
→ The current radio frequency will appear on the display.
→ If an FM station is received in stereo, ∞ is displayed.
- 2 Press TUNER on the remote control again to select the desired waveband: FM or AM.
- 3 Press and hold ◀ or ▶ on the remote control until the frequency indication starts to change, then release.
→ **SEARCHING...** will be displayed until a radio station with sufficient signal strength is found.
- 4 If necessary repeat step 3 until you find the desired radio station.

To tune to a weak station

Press ◀ or ▶ on the remote control briefly and repeatedly until optimal reception is achieved.

Automatic Preset Programming

- 1 Press TUNER on the remote control to select TUNER.
- 2 Press and hold VIEW FAVORITES for 5 seconds.
→ **AUTO PROGRAM FAVORITE STATIONS?** is displayed.
- 3 Press the red button (SUBTITLE) on the remote control to select YES.
→ **AUTO PROGRAM IN PROGRESS...** is displayed.
→ All available radio stations with sufficient signal strength will be stored automatically.
→ When all the available radio stations are stored or the memory for 40 presets is used, the last preset radio station will be played.

To stop storing the automatic preset

- Press ■.

Storing favorite radio stations manually

You can store up to 40 favorite radio stations in the memory.

- 1 Tune to your desired radio station (refer to "Tuning to radio stations").
- 2 Press (UN)MARK FAVORITES on the remote control.
→ The current station will be stored in the next available preset number.
→ will appear at the side of the display.
- Repeat steps 1–2 to store other radio stations.

Notes:

The favorites function for TUNER is not user dependent. The same favorites list applies for all users.

*If you attempt to store more than 40 preset radio stations, **NO MORE FAVORITES CAN BE ADDED** is displayed.*

Selecting a favorite radio station

- 1 Press ▲ or ▼ on the remote control to select the desired preset radio station from the favorite list.
- 2 Press ▶OK on the remote control to confirm.
→ The preset number, radio frequency, and waveband are displayed.

Deleting a favorite radio station

- 1 Press ▲ or ▼ on the remote control to select the desired preset radio station from the favorite list.
- 2 Press (UN)MARK FAVORITES on the remote control.
→ ERASE SELECTED RADIO STATION? is displayed.
- 3 Press the red button (SUBTITLE) on the remote control to delete the radio station.
→ The radio station continues to play but has been deleted from the favorites list. All following favorite radio stations will decrease their preset number by one.

Deleting all favorite radio stations

- 1 While TUNER is selected, press and hold (UN)MARK FAVORITES for more than 5 seconds.
→ DO YOU WANT TO DELETE ALL TUNER FAVOURITES? is displayed.
- 2 Press the red button (SUBTITLE) on the remote control to confirm.
→ All the preset stations will be deleted.

Changing the order of favorite radio stations

- 1 Press ▲ or ▼ on the remote control to select the desired preset radio station from the favorite list.
 - 2 To move the radio station down in the favorites list, press the red button (SUBTITLE) on the remote control.

To move the radio station up in the favorites list, press the green button (ANGLE) on the remote control.
- If necessary repeat steps 1–2 for other radio stations.

Troubleshooting

WARNING

Under no circumstances should you try to repair the unit yourself as this will invalidate the warranty. Do not open the unit as there is a risk of electric shock.

If a fault occurs, first check the points listed before taking the unit for repair. If you are unable to solve a problem by following these hints, consult your dealer or service center.

Problem

Solution

Disc does not playback.

- Make sure the correct program number (channel number) for the Streamium System has been selected on the TV.
- Make sure the Streamium System and the TV are connected properly.
- Make sure the disc is not scratched or dirty. Replace or clean the disc.
- Make sure the disc has been inserted, printed side up.
- Make sure you have inserted the right disc type: DVD, (Super) Video CD, Audio CD, CDR(W) or MP3-CD.
- Make sure the region code of the DVD matches the Streamium System.
- Change the Parental level (See "Access control").
- Press SYSTEM MENU to exit the system menu.

Cannot activate some features, such as angles, subtitles or multi-language Audio.

- The features may not be available on the disc. Try another disc.

No sound or distorted sound

- Adjust the volume.
- Check the speaker connections and settings.
- Disconnect the headphones.
- Press ►OK to resume normal playback.
- Press the corresponding source button on the remote control (DVD, INTERNET, ...) to choose the source you want to hear through the Streamium System.

No sound from the center and/or surround speakers.

- Make sure the center and surround speakers are connected correctly.
- Press SURROUND on the remote control to select another surround effect.

No digital surround sound

- Make sure the selected source (inserted disc, Internet media, ...) supports digital surround sound (Dolby Digital, DTS, MPEG).
- Make sure external equipment that plays digital surround sound is connected to DIGITAL IN.

Radio reception is poor.

- If the signal is too weak, adjust the antenna or connect an external antenna for better reception.
- Place the antenna farther away from other equipment (TV, VCR, digital equipment, ...) that may disturb radio reception.
- Increase the distance between the Streamium System and your TV or VCR.

The remote control does not function properly.

- Press the desired source button **on the remote control** (DVD, INTERNET, ...), then press the desired function button (e.g. ►OK, ►►).

The Streamium System does not respond to any of the buttons, including the standby button.

- Unplug the power cord and wait at least 10 seconds before reconnecting the unit.

Problem	Solution
VCR or other recording equipment connected to the Streamium system does not record sound correctly	<ul style="list-style-type: none"> – Press SURROUND repeatedly to select STEREO. – With equipment connected to DIGITAL OUT, make sure the setting of “Digital output” in the System menu is correct. See “Digital output” on page 41.
No picture or distorted picture	<ul style="list-style-type: none"> – Make sure the P-SCAN switch on the rear of the Streamium System is set to ON if you connected a Pro Scan capable TV to COMPONENT P_R P_B Y on the Streamium System. – Press and hold the green button (ANGLE) on the remote control for 6 seconds to reset the video settings. Next, read “No picture or distorted picture” on page 17. – Use the CVBS connection instead of S-Video or Component Video to connect your TV to the Streamium System. For this, press and hold the green button (ANGLE) on the remote control for 6 seconds to reset the video settings, disconnect the Streamium System from the power supply and follow the instructions in “Using Composite Video (CVBS)” on page 14.
No video signal available on video output jacks (CVBS, S-Video, Component)	<ul style="list-style-type: none"> – When INTERNET or PC LINK is selected, a video signal will be available either on the Component Video or on the CVBS and S-Video jacks. See “No picture or distorted picture” on page 17 to switch between Component Video and S-Video/CVBS.
Playback of Internet services skips or interrupts	<ul style="list-style-type: none"> – If you share the broadband Internet access with other users, there may not be enough broadband Internet bandwidth available to the Streamium System.
Media file (music, video or photo) does not play or in poor quality only	<ul style="list-style-type: none"> – The file format of the media file may not be supported by the Streamium System. Play a media file with a supported file format. Visit http://My.Philips.com for the latest information on supported file formats. – The wireless reception is low. Change the position of your wireless equipment to improve the reception. – The media has been recorded in low quality, e. g. music files with a low bitrate (64 kbps).
No connection to the Internet	<p><u>General solutions, always try first:</u></p> <ul style="list-style-type: none"> – Press INTERNET again. If necessary, repeat this step several times. – Make sure the computers in your network connect to the Internet. If they do not, consult your network administrator or Internet service provider.
“The system could not connect to the server.” appears	<ul style="list-style-type: none"> – Check if your (wireless) router and your cable modem are connected properly to each other. – Your Internet service provider uses a proxy. Press the green button (ANGLE) on the remote control to enter the proxy name and the proxy port.
“An IP address could not be obtained automatically.” appears	<ul style="list-style-type: none"> – If you use a (wireless) router, make sure “DHCP server” is enabled in the configuration menu of the router. – Press the green button (ANGLE) on the remote control to enter the IP settings manually.
“The WEP key you entered has an invalid format.” appears	<ul style="list-style-type: none"> – All WEP keys must have the same format (either ASCII or HEX format) and the same length (ASCII: either 5 or 13 characters, HEX: either 10 or 26 digits).
Cannot access Internet media after entering the email address	<ul style="list-style-type: none"> – After entering your email address, you will get an email with instructions on how to create a user account. Please follow these instructions. Next, press INTERNET on the remote control.

Troubleshooting

Problem

**INTERNET, PC LINK:
Streamium System freezes
during startup**

Solution

- Press STANDBY·ON to switch off the Streamium System. Next, press INTERNET or PC LINK to switch it on again.
- If the Streamium System does not react when you press STANDBY·ON, disconnect the Streamium System from the power supply and wait at least 10 seconds before reconnecting the Streamium System.
- If the Streamium System freezes during startup before you can see the INTERNET or PC LINK menu and if the hints above do not help, the Streamium System may need a reinstallation of the software:
 - 1** Make sure the Streamium System has access to the Internet through a wired connection. If necessary, connect the Streamium System to a free LAN port on your router (see page 24). Do not use a wireless connection.
 - 2** Disconnect the Streamium System from the power supply.
 - 3** Press and hold the red button (SUBTITLE) on the remote control while you reconnect the power cord to the power supply.
 - 4** Follow the instructions on the TV screen or on the display of the Streamium System to establish a connection to the Internet and to reinstall the software of the Streamium System.

Please take the following problems/solutions into account:

Problem

PC LINK: It takes about 2 minutes before the Streamium System connects to the PC (Windows operating system only)

PC LINK: The Streamium System does not connect to the PC (Windows operating system only)

Solution

- Your PC may assign an IP address to itself automatically (Auto-IP). This can take some time. Run the Philips AutoIP utility. See the chapter below.
- The PC may not get an IP address automatically. Run the Philips AutoIP utility. See the chapter below.

Using the Philips AutoIP utility

Run the Philips AutoIP utility on your PC if you have a direct connection between the Streamium System and your PC (case B on page 23 or case D on page 25 of the user manual).

Do not run the Philips AutoIP Utility if you have a wired or wireless home network using a base station, router or gateway (case A on page 21 or case C on page 24 of the user manual)

- 1** Press PC LINK on the Streamium System.
- 2** Insert the Philips Media Manager CD-ROM into the CD-ROM drive of your PC. Go to the folder "Software" → "Tools".
- 3** Double-click the "PhilipsAutoIPutility.exe" file to start the AutoIP utility.
 - In some cases "Auto IP" may be deactivated on your computer completely and you will be asked if you want to enable Auto IP on your PC. Click on "OK". Please be aware that your PC will restart. Continue with step 2.
 - A list with all network adapters found on your computer will appear. The list may include old adapters that were not properly uninstalled.

- 4** Click on the adapter which you want to use for the communication between the PC and the Streamium System.

5 If the status of the adapter is "DHCP only":

- Click the "Enable AutoIP" button.
- The status changes to "DHCP/AutoIP".

If the status of the adapter is "DHCP/AutoIP" or "AutoIP":

Wait until the IP address changes to 169.254.x.x. x is a number between 0 and 255.

Next, click the "Lock AutoIP" button.

- The PC is properly set up now.

If the status of the adapter is "Static IP":

In this case the AutoIP utility cannot make any changes on your computer:

Either change the network settings of the Windows operating system to "Obtain IP address automatically" and continue with step 4 or

enter a static IP on the Streamium System. For this, press SYSTEM MENU and select **Network → Network Config**.

- 6** Click the "Exit" button to exit the AutoIP utility.
- 7** Press STANDBY·ON to switch the Streamium System to standby. Next, press PC LINK. The Streamium System should connect instantly to the PC now.

Note: You can reverse the settings of the AutoIP utility by clicking again on the corresponding button.

Subject to modification without notice.

General

Power supply rating	120 V / 60 Hz
Power consumption	
Active	118 W
Standby	< 0.5 W
Dimensions (w x h x d)	17.1" x 3.8" x 14.6"
Weight	8.0 kg, 17.6 lbs

Amplifier

Output power	
Total output power	450 W RMS 360 W FTC*
Stereo mode	2 x 75 W RMS 2 x 60 W FTC
Surround mode	
Front	2 x 75 W RMS / 60 W FTC
Center	75 W RMS / 60 W FTC
Surround	2 x 75 W RMS / 60 W FTC
Subwoofer	75 W RMS / 60 W FTC
Total Harmonic Distortion	10%, 1 kHz, 66 W
S/N ratio (unweighted)	≥ 92 dB
(A-weighted)	100 dBA
Crosstalk (1 kHz)	≥ -90 dB

* 4 Ω, 120 Hz–12.5 kHz, 10% THD

Tuner

Tuning range	
FM	87.5 MHz–108 MHz
AM	530 kHz–1700 kHz

DVD

Disc diameter	12 cm / 8 cm
Video Decoding	MPEG-2 / MPEG-1
Video DAC	9 bit, 5 channels
Signal system	NTSC
Video format	4:3 / 16:9
Video S/N	56 dB (minimum)
Supported disc formats	DVD, DVD+R, DVD+RW, (Super) Video CD, Audio CD, CD-R, CD-RW, MP3-CD (ISO 9660)

INTERNET and PC LINK

Ethernet	IEEE 802.3, 10/100 Base-T
Wireless	Wi-Fi Certified, IEEE 802.11g
Supported media formats (at the time of printing)	
Music	MP3 and MP3pro streams, 32–320 kbit/sec, variable bit rate
Pictures	JPEG, JPEG2000, .bmp, .gif
Video	MPEG 1, MPEG 2, MPEG 4, DivX 4.0/5.03

Analog audio connections

Analog in (AUX IN, TV IN)	500 mV – 2 V / 22 kΩ
Analog out (LINE OUT)	Stereo, 1.5 V / 1 kΩ, S/N 105 dB

Video connections

Video out (Component Video)	
Y	1.0 V _{p-p} , 75 Ω
P _B , P _R	0.7 V _{p-p} , 75 Ω
Video out (S-VIDEO)	
Y	1.0 V _{p-p} , 75 Ω
C	0.286 V _{p-p} , 75 Ω
Video out (CVBS)	1.0 V _{p-p} , 75 Ω

Digital connections

Digital Input/Output SPDIF (Sony Philips digital interface)	
In	> 200 mV _{p-p} / 75 Ω
Out	500 mV _{p-p} / 75 Ω
PCM	acc. IEC 60958
Dolby Digital/DTS	acc. IEC 60958, IEC 61937
Audio DAC	24 bit / 96 kHz
Frequency Response	
44.1 kHz	10 Hz – 20 kHz
48 kHz	10 Hz – 22 kHz
96 kHz	10 Hz – 44 kHz

Speaker and headphones connections

Front, center and rear speakers	4 Ω
Subwoofers	8 Ω
Headphone (6.3 mm, 8–600 Ω)	2.8V EMF, R _L = 80 Ω

Antenna connections

FM antenna	75 Ω
AM antenna	300 Ω

Speakers

Front and rear speakers	
System	2 way shielded, Closed Box
Impedance	4 Ω
Speaker drivers	2 x 3" woofers, 1 x 1 ³ / ₄ " tweeter
Dimensions (w x h x d)	3.7" x 11.0" x 2.8"
Center speaker	
System	2 way shielded, Closed Box
Impedance	4 Ω
Speaker drivers	4 x 2" woofers, 1 x 1 ³ / ₄ " tweeter
Dimensions (w x h x d)	17.1" x 2.9" x 2.6"
Subwoofer	
System	Bass Reflex
Impedance	8 Ω
Speaker driver	4" woofer
Dimensions base (w x h)	9.4" x 1.2"
Dimensions tube (w x h)	4.5" x 37.9"

LIMITED WARRANTY

AUDIO SYSTEM

One Year Free Labor

One Year Free Service on Parts

This product must be carried in for repair.

WHO IS COVERED?

You must have proof of purchase to receive warranty service. A sales receipt or other document showing that you purchased the product is considered proof of purchase.

WHAT IS COVERED?

Warranty coverage begins the day you buy your product. For one year thereafter, all parts will be repaired or replaced, and labor is free. After one year from the day of purchase, you pay for the replacement or repair of all parts, and for all labor charges.

All parts, including repaired and replaced parts, are covered only for the original warranty period. When the warranty on the product expires, the warranty on all replaced and repaired parts also expires.

WHAT IS EXCLUDED?

Your warranty does not cover:

- labor charges for installation or setup of the product, adjustment of customer controls on the product, and installation or repair of antenna systems outside of the product.
- product repair and/or part replacement because of misuse, accident, unauthorized repair or other cause not within the control of Philips.
- reception problems caused by signal conditions or cable or antenna systems outside the unit.
- a product that requires modification or adaptation to enable it to operate in any country other than the country for which it was designed, manufactured, approved and/or authorized, or repair of products damaged by these modifications.
- incidental or consequential damages resulting from the product. (Some states do not allow the exclusion of incidental or consequential damages, so the above exclusion may not apply to you. This includes, but is not limited to, prerecorded material, whether copyrighted or not copyrighted.)
- a product that is used for commercial or institutional purposes.

WHERE IS SERVICE AVAILABLE?

Warranty service is available in all countries where the product is officially distributed by Philips. In countries where Philips does not distribute the product, the local Philips service organization will attempt to provide service (although there may be a delay if the appropriate spare parts and technical manual(s) are not readily available).

MAKE SURE YOU KEEP...

Please keep your sales receipt or other document showing proof of purchase. Attach it to this owner's manual and keep both nearby. Also keep the original box and packing material in case you need to return your product.

BEFORE REQUESTING SERVICE...

Please check your owner's manual for assistance. If you have additional questions, call us at 1-800-531-0039.

TO GET WARRANTY SERVICE IN U.S.A., PUERTO RICO, OR U.S. VIRGIN ISLANDS...

Take the product to a Philips factory service center (see enclosed list) or authorized service center for repair. When the product has been repaired, you must pick up the unit at the center. Centers may keep defective parts. (In U.S.A., Puerto Rico, and U.S. Virgin Islands, all implied warranties, including implied warranties of merchantability and fitness for a particular purpose, are limited in duration to the duration of this express warranty. But, because some states do not allow limitations on how long an implied warranty may last, this limitation may not apply to you.)

TO GET WARRANTY SERVICE IN CANADA...

Please contact Philips at:

1-800-661-6162 (French Speaking)

1-800-531-0039 (English or Spanish Speaking)

(In Canada, this warranty is given in lieu of all other warranties. No other warranties are expressed or implied, including any implied warranties of merchantability or fitness for a particular purpose. Philips is not liable under any circumstances for any direct, indirect, special, incidental or consequential damages, howsoever incurred, even if notified of the possibility of such damages.)

REMEMBER...

Please record below the model and serial numbers found on the product. Also, please fill out and mail your warranty registration card promptly. It will be easier for us to notify you if necessary.

MODEL # _____

SERIAL # _____

This warranty gives you specific legal rights. You may have other rights which vary from state/province to state/province.

Philips, P.O. Box 520890, Miami, FL 33152, USA, (402) 536-4171

EL4965E007 / 8-02

1 Insert batteries

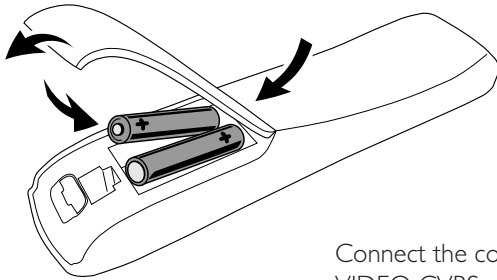

2 Connect TV

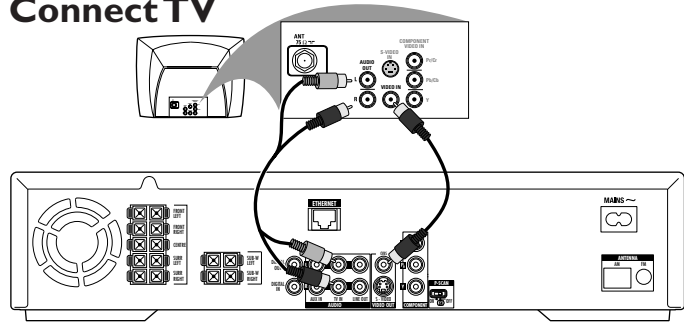

Connect the composite video input jack on the TV (labelled A/V In, Video In, Composite) to VIDEO CVBS on the Streamium System with the supplied composite video cable (yellow). For Component or S-Video connections, see page 14 of the user's manual.

Connect the audio output jacks on the TV to TV IN (L/R) on the Streamium System with the supplied RCA-style audio cable (white and red).

3 Connect speakers and antenna

Match the colors of the speaker cables and of the speaker jacks!

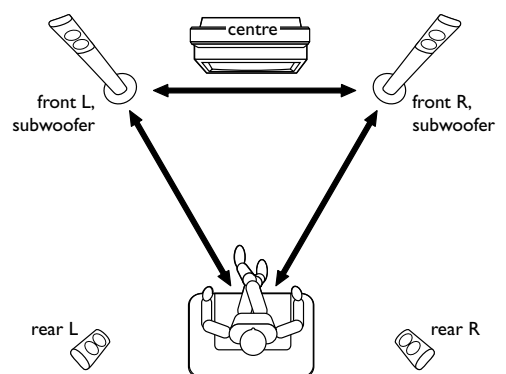
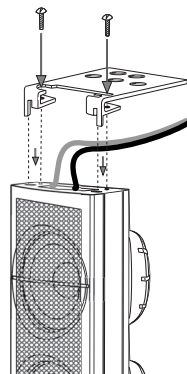
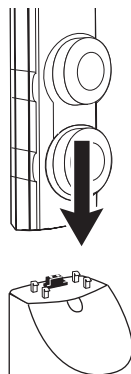
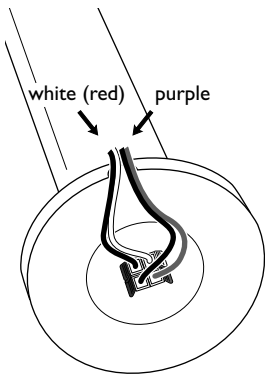

1 Connect the speaker cables to the base of the subwoofers.

2 Mount the 2 front speakers (white, red jack) onto the 2 subwoofers.

3 Mount the 2 mini speaker stands onto the 2 rear speakers (blue, grey jack) and connect the corresponding speaker cables.

4 Position the speakers.

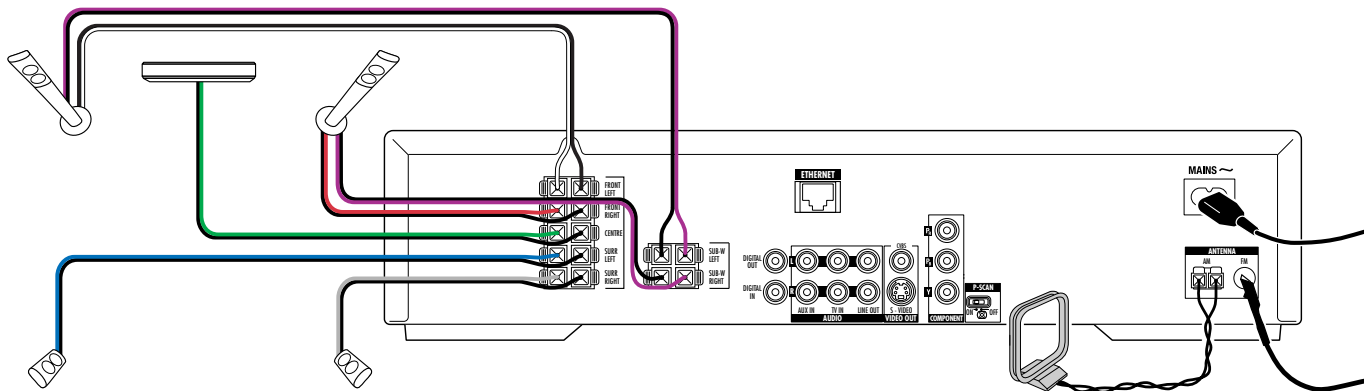

5 Connect the speaker cables to the Streamium System.

6 Connect the FM and the AM antenna.

7 After making all other connections connect the power cord to MAINS ~ on the Streamium System and to the power outlet.

4 Install the tuner

- 1 Press TUNER on the remote control.
- 2 Press and hold VIEW FAVORITES on the remote control for 5 seconds.
→ AUTO PROGRAM FAVORITE STATIONS? is displayed.
- 3 Press the red button (SUBTITLE) on the remote control to start the installation of radio stations.
→ It may take several minutes to search and store the radio stations.

5 Switch on the TV

- 1 Switch on your TV.
- 2 Press AUX on the remote control of the Streamium System.
- 3 Set the TV to the correct audio/video channel for the Streamium System: AV IN, AUX, EXT1, 2, ...
→ The Philips Streamium startup screen will appear on the TV screen.

If you have any problems with the picture quality, please read page 17 of the user's manual.

6 Install the Philips Media Manager

With the installation of the Philips Media Manager software on your computer, you can make the media files on your computer available to the Streamium System.

- 1 Download the latest version of the Philips Media Manager software at "My.Philips.com" or insert the supplied CD-ROM into the CD-ROM drive of your computer.
- 2 Double-click the "PMMSetup.exe" file to install the Philips Media Manager software on your computer(s). During the installation you will be asked which media files should be added to the Philips Media Manager.

7 Option A

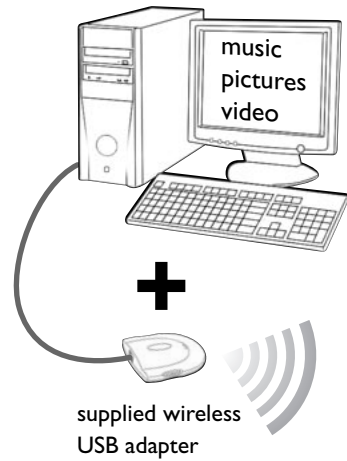

You have

- a computer with a free USB port (USB 2.0 recommended)
- Windows 98 SE or later

With the installation of the supplied wireless USB adapter on your computer you get a wireless connection to the Streamium System. Then you can access the media files of your computer with your Streamium Home Entertainment System.

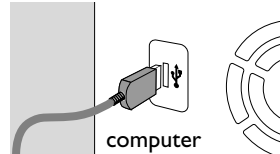
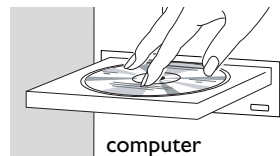
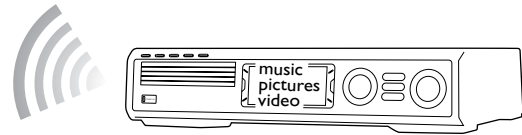

Install the supplied wireless USB adapter on your computer

- 1 Insert the installation disc of the USB adapter into the disc drive of your computer. The installation guide on the CD-ROM will start automatically.
- 2 Follow the on-screen instructions on the computer. Connect the wireless USB adapter to the free USB port on your computer when the installation guide asks you to do so.

Play music, picture and video from your computer with the Streamium System

- 1 Press PC LINK on the remote control.
→ The computer name will appear on the TV screen.
- 2 Press OK to access music, pictures and video on your computer.

If you have trouble connecting to the computer, press PC LINK again. See page 23 of the user's manual for additional help.

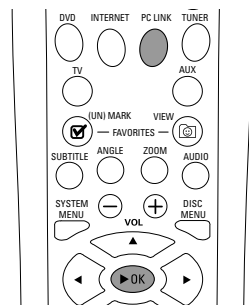

or

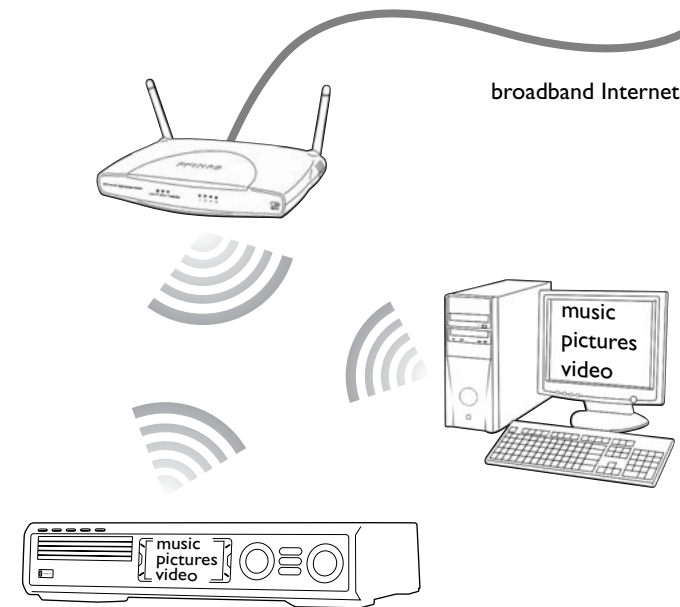

Option B

You have

- broadband Internet
- a wireless base station (not included)
- computer connected to the wireless network
PC: Windows 98 SE or later;
Apple Macintosh: Mac OS 10.1.5 or higher

First, make sure all computers of your network connect to the Internet and to each other.

Play online music, picture and video services with the Streamium System

- 1 Press INTERNET on the remote control.
→ You will be asked to enter your email address.
- 2 Use the remote control to enter your email address and press OK to confirm.
Example: Press twice for "@". To delete a character, press .
- 3 You will receive an email with instructions on how to create your user account at "My.Philips.com".
- 4 After creating your user account, press INTERNET on the remote control to access online media services.

Play music, picture and video from your computer with the Streamium System

- 1 Press PC LINK on the remote control.
→ The available computer names will appear on the TV screen.
- 2 Select a computer and press OK to access music, pictures and video on the computer.

If you have trouble connecting to the Internet or to your computers, press INTERNET or PC LINK again. See pages 21-22 in the user's manual for additional help.

8 Select and play media

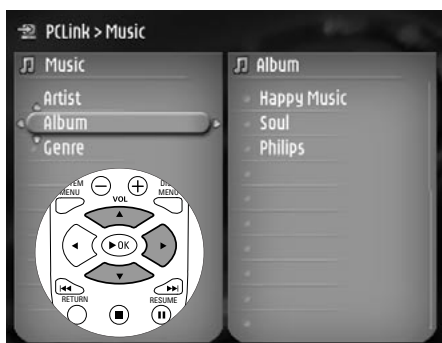

- 1 Press ▲ or ▼ to move up or down in the menu.
- 2 Press ► to enter the menu to the right.



- 3 Repeat step 1 and 2 to navigate to the desired playable item (Internet radio station, movie, album, track, ...)

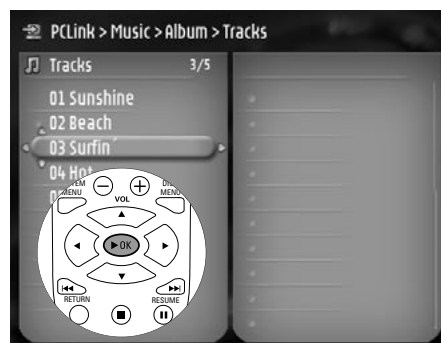

- 4 Press ►OK to play the playable item.
 - To go back to the previous (left) menu, press ◀.
 - To stop playback, press ■.

9 Play a disc

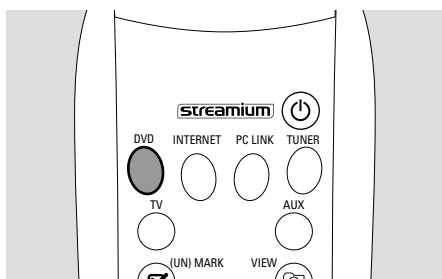

- 1 Press DVD on the remote control.

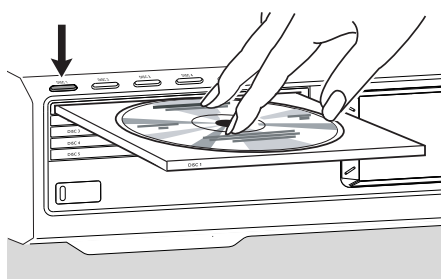

- 2 Press DISC 1 (OPEN/CLOSE ▲) to open tray 1.
- 3 Insert a disc into tray 1.
- 4 Press DISC 1 (OPEN/CLOSE ▲) to close tray 1.

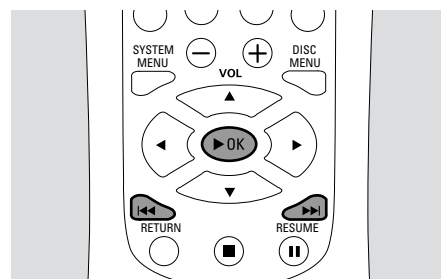

- 5 Press ►OK to start playback. Some discs will start automatically.
 - To skip to previous or following chapters/tracks, press ◀◀ or ▶▶ repeatedly.

Please visit <http://My.Philips.com>

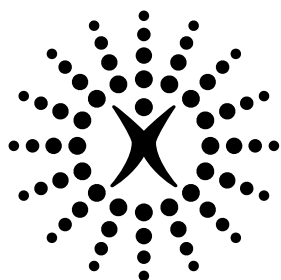

connectedplanet

PHILIPS CONSUMER ELECTRONICS NORTH AMERICA

Knoxville, Tennessee 37914-1810, U.S.A.



Printed in China



3103 306 1975.3

